

BLF 5.08HC/10/90F SN OR BX

Weidmüller Interface GmbH & Co. KG

Klingenbergstraße 26

D-32758 Detmold

Germany

www.weidmueller.com

Product image

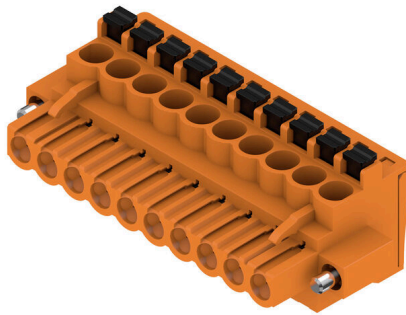

Just as reliable as the millionfold proven original and featuring innovative details:

The BLF 5.08HC PUSH IN version of the BLZP 5.08HC female connector is not only different in terms of connection system; it also has a more compact design. Weidmüller's innovative PUSH IN spring connection system stands for the future of easy and tool-free wire connection. HC = High Current.

In terms of versatility, the BLF 5.08HC offers just as much as the version which served as a model:

- 3 tested-and-proven wire outlet directions provide the usual flexibility for application-specific design
- 4 flange variations and the patented release latch allow the locking concept to be based on the requirements of the user
- Use the BLF 5.08HC and SL 5.08HC plug combination to reach the max. rated specifications

General ordering data

Version	PCB plug-in connector, female plug, 5.08 mm, Number of poles: 10, 90°, PUSH IN with actuator, Clamping range, max.: 3.31 mm², Box
Order No.	1002170000
Type	BLF 5.08HC/10/90F SN OR BX
GTIN (EAN)	4032248694327
Qty.	30 items
Product data	IEC: 400 V / 24 A / 0.2 - 2.5 mm² UL: 300 V / 18.5 A / AWG 26 - AWG 12
Packaging	Box

BLF 5.08HC/10/90F SN OR BX

Weidmüller Interface GmbH & Co. KG
 Klingenbergstraße 26
 D-32758 Detmold
 Germany

www.weidmueller.com

Technical data

Approvals

Approvals



ROHS	Conform
UL File Number Search	UL Website
Certificate No. (cURus)	E60693

Dimensions and weights

Depth	26.2 mm	Depth (inches)	1.0315 inch
Height	20.6 mm	Height (inches)	0.811 inch
Width	60.6 mm	Width (inches)	2.3858 inch
Net weight	20.5 g		

Environmental Product Compliance

RoHS Compliance Status	Compliant without exemption		
REACH SVHC	No SVHC above 0.1 wt%		
Product Carbon Footprint	Cradle to gate	0,696 kg CO2 eq.	

System Parameters

Product family	OMNIMATE Signal - series BL/SL 5.08		
Type of connection	Field connection		
Wire connection method	PUSH IN with actuator		
Pitch in mm (P)	5.08 mm		
Pitch in inches (P)	0.200 "		
Conductor outlet direction	90°		
Number of poles	10		
L1 in mm	45.72 mm		
L1 in inches	1.800 "		
Number of rows	1		
Pin series quantity	1		
Rated cross-section	2.5 mm ²		
Touch-safe protection acc. to DIN VDE 57 106	Safe from finger touch		
Touch-safe protection acc. to DIN VDE 0470	IP20 plugged/ IP10 unplugged		
Protection degree	IP20		
Volume resistance	≤5 mΩ		
Can be coded	Yes		
Stripping length	10 mm		
Screwdriver blade	0.6 x 3.5		
Screwdriver blade standard	DIN 5264		
Plugging cycles	25		
Plugging force/pole, max.	7 N		
Pulling force/pole, max.	5.5 N		
Tightening torque	Torque type	Screw flange	
	Usage information	Tightening torque	min. 0.2 Nm max. 0.25 Nm

BLF 5.08HC/10/90F SN OR BX

Weidmüller Interface GmbH & Co. KG

Klingenbergstraße 26
D-32758 Detmold
Germany

www.weidmueller.com

Technical data

Material data

Insulating material	PBT	Colour	orange
Colour chart (similar)	RAL 2000	Insulating material group	IIIa
Comparative Tracking Index (CTI)	≥ 200	Moisture Level (MSL)	
UL 94 flammability rating	V-0	Contact material	Cu-alloy
Contact surface	tinned	Layer structure of plug contact	4...8 µm Sn hot-dip tinned
Storage temperature, min.	-40 °C	Storage temperature, max.	70 °C
Operating temperature, min.	-50 °C	Operating temperature, max.	100 °C
Temperature range, installation, min.	-30 °C	Temperature range, installation, max.	100 °C

Conductors suitable for connection

Clamping range, min.	0.13 mm ²
Clamping range, max.	3.31 mm ²
Wire connection cross section AWG, min.	AWG 26
Wire connection cross section AWG, max.	AWG 12
Solid, min. H05(07) V-U	0.2 mm ²
Solid, max. H05(07) V-U	2.5 mm ²
Flexible, min. H05(07) V-K	0.2 mm ²
Flexible, max. H05(07) V-K	2.5 mm ²
w. plastic collar ferrule, DIN 46228 pt 4, min.	0.25 mm ²
w. plastic collar ferrule, DIN 46228 pt 4, max.	2.5 mm ²
w. wire end ferrule, DIN 46228 pt 1, min.	0.25 mm ²
w. wire end ferrule, DIN 46228 pt 1, max.	2.5 mm ²
Plug gauge in accordance with EN 60999 a x b; ø	2.8 mm x 2.0 mm

Clampable conductor	Cross-section for conductor connection	Type	fine-wired
		nominal	0.5 mm ²
wire end ferrule	wire end ferrule	Stripping length	nominal 12 mm
		Recommended wire-end ferrule	H0.5/16 OR
		Stripping length	nominal 10 mm
		Recommended wire-end ferrule	H0.5/10
Cross-section for conductor connection	wire end ferrule	Type	fine-wired
		nominal	0.75 mm ²
		Stripping length	nominal 12 mm
		Recommended wire-end ferrule	H0.75/16 W
Cross-section for conductor connection	wire end ferrule	Stripping length	nominal 10 mm
		Recommended wire-end ferrule	H0.75/10
		Type	fine-wired
		nominal	1 mm ²
Cross-section for conductor connection	wire end ferrule	Stripping length	nominal 12 mm
		Recommended wire-end ferrule	H1.0/16D R
		Stripping length	nominal 10 mm
		Recommended wire-end ferrule	H1.0/10
Cross-section for conductor connection	wire end ferrule	Type	fine-wired
		nominal	1.5 mm ²
		Stripping length	nominal 10 mm

BLF 5.08HC/10/90F SN OR BX

Weidmüller Interface GmbH & Co. KG
 Klingenbergstraße 26
 D-32758 Detmold
 Germany

www.weidmueller.com

Technical data

		Recommended wire-end ferrule	H1,5/10
		Stripping length	nominal 12 mm
		Recommended wire-end ferrule	H1,5/16 R
Cross-section for conductor connection		Type	fine-wired
		nominal	2.5 mm ²
wire end ferrule		Stripping length	nominal 10 mm
		Recommended wire-end ferrule	H2,5/10
		Stripping length	nominal 13 mm
		Recommended wire-end ferrule	H2,5/16DS BL

Reference text The outside diameter of the plastic collar should not be larger than the pitch (P), Length of ferrules is to be chosen depending on the product and the rated voltage.

Rated data acc. to IEC

tested acc. to standard	IEC 60664-1, IEC 61984	Rated current, min. number of poles (Tu=20°C)	24 A
Rated current, max. number of poles (Tu=20°C)	19 A	Rated current, min. number of poles (Tu=40°C)	21 A
Rated current, max. number of poles (Tu=40°C)	16.5 A	Rated voltage for surge voltage class / pollution degree II/2	400 V
Rated voltage for surge voltage class / pollution degree III/2	320 V	Rated voltage for surge voltage class / pollution degree III/3	250 V
Rated impulse voltage for surge voltage class/ pollution degree II/2	4 kV	Rated impulse voltage for surge voltage class/ pollution degree III/2	4 kV
Rated impulse voltage for surge voltage class/ contamination degree III/3	4 kV	Short-time withstand current resistance	3 x 1s with 120 A

Rated data acc. to CSA

Institute (CSA)	CSA	Certificate No. (CSA)	200039-1121690
Rated voltage (Use group B / CSA)	300 V	Rated voltage (Use group D / CSA)	300 V
Rated current (Use group B / CSA)	10 A	Rated current (Use group D / CSA)	10 A
Wire cross-section, AWG, min.	AWG 12	Wire cross-section, AWG, max.	AWG 26
Reference to approval values	Specifications are maximum values, details - see approval certificate.		

Rated data acc. to UL 1059

Institute (cURus)	CURUS	Certificate No. (cURus)	E60693
Rated voltage (Use group B / UL 1059)	300 V	Rated voltage (Use group D / UL 1059)	300 V
Rated current (Use group B / UL 1059)	18.5 A	Rated current (Use group D / UL 1059)	10 A
Wire cross-section, AWG, min.	AWG 26	Wire cross-section, AWG, max.	AWG 12
Reference to approval values	Specifications are maximum values, details - see approval certificate.		

Packing

Packaging	Box	VPE length	348.00 mm
VPE width	135.00 mm	VPE height	32.00 mm

Type tests

Test: Durability of markings	Standard	DIN EN 61984 section 7.3.2 / 09.02 taking pattern from DIN EN 60068-2-70 / 07.96
------------------------------	----------	--

BLF 5.08HC/10/90F SN OR BX

Weidmüller Interface GmbH & Co. KG
 Klingenbergstraße 26
 D-32758 Detmold
 Germany

www.weidmueller.com

Technical data

	Test	mark of origin, type identification, pitch, type of material, date clock	
	Evaluation	available	
	Test	durability	
	Evaluation	passed	
Test: Misengagement (Non-interchangeability)	Standard	DIN EN 61984 section 6.3 and 6.9.1 / 09.02, DIN EN 60512-13-5 / 11.08	
	Test	180° turned with coding elements	
	Evaluation	passed	
	Test	visual examination	
	Evaluation	passed	
Test: Clampable cross section	Standard	DIN EN 60999-1 section 7 and 9.1 / 12.00, DIN EN 60947-1 section 8.2.4.5.1 / 04.08	
	Conductor type	Type of conductor and conductor cross-section	solid 0.2 mm ²
		Type of conductor and conductor cross-section	stranded 0.2 mm ²
		Type of conductor and conductor cross-section	solid 2.5 mm ²
		Type of conductor and conductor cross-section	stranded 2.5 mm ²
		Type of conductor and conductor cross-section	AWG 26/1
		Type of conductor and conductor cross-section	AWG 26/19
		Type of conductor and conductor cross-section	AWG 14/1
		Type of conductor and conductor cross-section	AWG 14/19
	Evaluation	passed	
Test for damage to and accidental loosening of conductors	Standard	DIN EN 60999-1 section 9.4 / 12.00	
	Requirement	0.2 kg	
	Conductor type	Type of conductor and conductor cross-section	AWG 26/1
		Type of conductor and conductor cross-section	AWG 26/19
	Evaluation	passed	
	Requirement	0.3 kg	
	Conductor type	Type of conductor and conductor cross-section	H05V-U0.5
		Type of conductor and conductor cross-section	H05V-K0.5
	Evaluation	passed	
	Requirement	0.7 kg	
Conductor type	Type of conductor and conductor cross-section	H07V-U2.5	
	Type of conductor and conductor cross-section	H07V-K2.5	
Evaluation	passed		

BLF 5.08HC/10/90F SN OR BX

Weidmüller Interface GmbH & Co. KG
 Klingenbergstraße 26
 D-32758 Detmold
 Germany

Technical data

www.weidmueller.com

	Requirement	0.9 kg
Pull-out test	Conductor type	Type of conductor and conductor cross-section AWG 12/1
		Type of conductor and conductor cross-section AWG 12/19
	Evaluation	passed
	Standard	DIN EN 60999-1 section 9.5 / 12.00
	Requirement	≥10 N
	Conductor type	Type of conductor and conductor cross-section AWG 26/1
		Type of conductor and conductor cross-section AWG 26/19
	Evaluation	passed
	Requirement	≥20 N
	Conductor type	Type of conductor and conductor cross-section H05V-U0.5
		Type of conductor and conductor cross-section H05V-K0.5
	Evaluation	passed
Requirement	≥50 N	
Conductor type	Type of conductor and conductor cross-section H07V-U2.5	
	Type of conductor and conductor cross-section H07V-K2.5	
Evaluation	passed	
Requirement	≥60 N	
Conductor type	Type of conductor and conductor cross-section AWG 12/1	
	Type of conductor and conductor cross-section AWG 12/19	
Evaluation	passed	

Important note

IPC conformity Conformity: The products are developed, manufactured and delivered according international recognized standards and norms and comply with the assured properties in the data sheet resp. fulfill decorative properties in accordance with IPC-A-610 "Class 2". Further claims on the products can be evaluated on request.

- Notes**
- Additional variants on request
 - Gold-plated contact surfaces on request
 - Rated current related to rated cross-section & min. No. of poles.
 - Wire end ferrule without plastic collar to DIN 46228/1
 - Wire end ferrule with plastic collar to DIN 46228/4
 - P on drawing = pitch
 - Crimping shape "A" for wire end ferrules with PZ 6/5 crimping tool recommended.
 - The test point can only be used as potential-pickup point.
 - In accordance with IEC 61984, OMNIMATE-connectors are connectors without breaking capacity (COC). During designated use, connectors are not allowed to be engaged or disengaged when live or under load
 - Long term storage of the product with average temperature of 50 °C and maximum humidity 70%, 36 months

BLF 5.08HC/10/90F SN OR BX

Weidmüller Interface GmbH & Co. KG
Klingenbergstraße 26
D-32758 Detmold
Germany

www.weidmueller.com

Technical data

Classifications

ETIM 8.0	EC002638	ETIM 9.0	EC002638
ETIM 10.0	EC002638	ECLASS 14.0	27-46-02-02
ECLASS 15.0	27-46-02-02		

BLF 5.08HC/10/90F SN OR BX

Weidmüller Interface GmbH & Co. KG
 Klingenbergstraße 26
 D-32758 Detmold
 Germany

www.weidmueller.com

Drawings

Product image

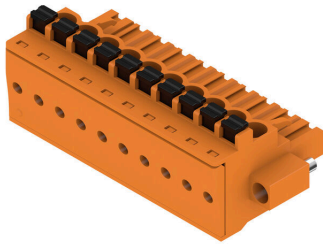

Dimensional drawing

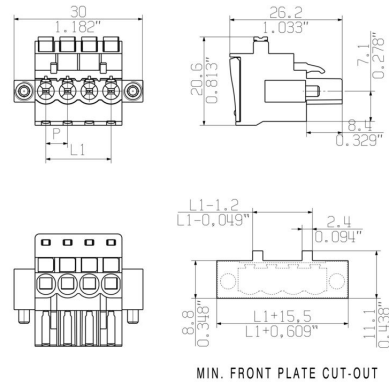

Graph

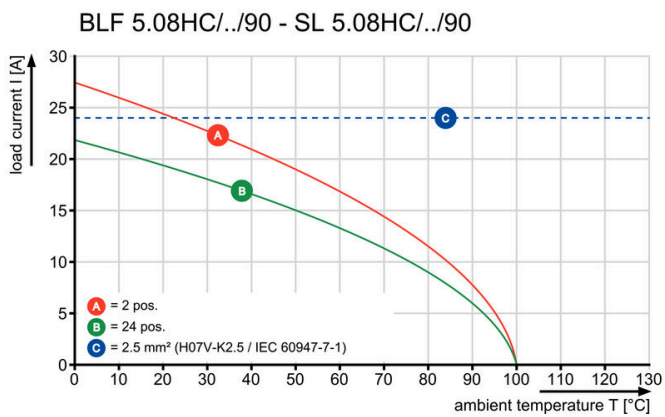

Graph

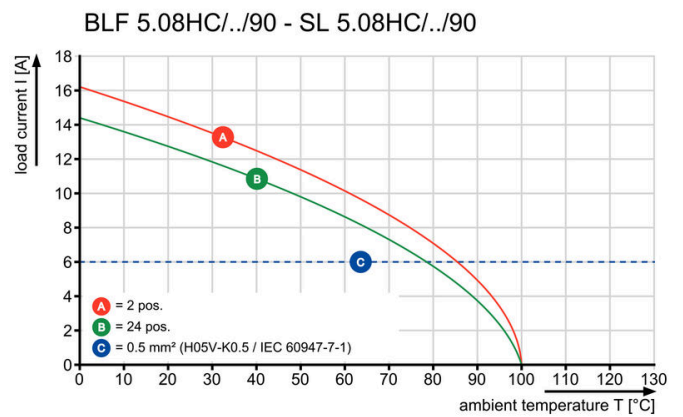

Uncompromising functionality High vibration resistance

Drawings

Product benefits



Solid PUSH IN contact Safe and durable

Product benefits



Cost-effective wiring Quick and intuitive operation

Product benefits



Wide clamping range Tool-free wire connection

BLF 5.08HC/10/90F SN OR BX

Weidmüller Interface GmbH & Co. KG
 Klingenbergstraße 26
 D-32758 Detmold
 Germany

www.weidmueller.com

Accessories

Coding elements



Only connects what is supposed to be connected: the right connection at the right place.
 Coding elements and locking devices clearly assign connecting elements during the manufacturing process and operation
 The coding elements and locking devices are inserted prior to assembly or during the cable assembly phase. The Weidmüller alternative: configure online using the variant configurator to precode prior to delivery. Incorrect assembly on the circuit board and incorrect plugging of connecting elements is no longer possible. The advantage: no troubleshooting during manufacture and no operational errors by the user.

General ordering data

Type	BLZ/SL KO BK BX	Version
Order No.	1545710000	PCB plug-in connector, Accessories, Coding element, black, Number
GTIN (EAN)	4008190087142	of poles: 1
Qty.	50 ST	
Type	BLZ/SL KO OR BX	Version
Order No.	1573010000	PCB plug-in connector, Accessories, Coding element, orange, Number
GTIN (EAN)	4008190048396	of poles: 1
Qty.	100 ST	

Slotted screwdriver



Slotted screwdriver with rounded blade SD DIN 5265, ISO 2380/2, output to DIN 5264, ISO 2380/1. ChromTop tip, SoftFinish grip

General ordering data

Type	SDS 0.6X3.5X100	Version
Order No.	2749340000	Screwdriver, Blade width (B): 3.5 mm, Blade length: 100 mm, Blade thickness (A): 0.6 mm
GTIN (EAN)	4050118895568	
Qty.	1 ST	
Type	SDS 0.6X3.5X200	Version
Order No.	9010110000	Screwdriver, Screwdriver
GTIN (EAN)	4032248300754	
Qty.	1 ST	
Type	SDIS 0.6X3.5X100	Version
Order No.	2749810000	Screwdriver, Blade width (B): 3.5 mm, Blade length: 100 mm, Blade thickness (A): 0.6 mm
GTIN (EAN)	4050118897012	
Qty.	1 ST	

BLF 5.08HC/10/90F SN OR BX

Weidmüller Interface GmbH & Co. KG
 Klingenbergstraße 26
 D-32758 Detmold
 Germany

Counterpart

www.weidmueller.com

SL 5.08HC/180F



Pin headers in glass-fibre-reinforced plastic with straight wire outlet; optimised for wave soldering. The flange variant (F) can be screwed onto the respective counter piece or the circuit board. There is no need for an extra screw to connect the circuit board when the solder flange (LF) version is used. This also protects the solder points from mechanical strain. All pin headers can be manually coded or ordered pre-coded. HC = High Current.

General ordering data

Type	SL 5.08HC/10/180F 3.2SN...	Version
Order No.	1148720000	PCB plug-in connector, male header, Flange, THT solder connection,
GTIN (EAN)	4032248931309	5.08 mm, Number of poles: 10, 180°, Solder pin length (l): 3.2 mm,
Qty.	30 ST	tinned, black, Box
Type	SL 5.08HC/10/180F 3.2SN...	Version
Order No.	1147380000	PCB plug-in connector, male header, Flange, THT solder connection,
GTIN (EAN)	4032248931408	5.08 mm, Number of poles: 10, 180°, Solder pin length (l): 3.2 mm,
Qty.	30 ST	tinned, orange, Box

SL 5.08HC/180LF



Pin headers in glass-fibre-reinforced plastic with straight wire outlet; optimised for wave soldering. The flange variant (F) can be screwed onto the respective counter piece or the circuit board. There is no need for an extra screw to connect the circuit board when the solder flange (LF) version is used. This also protects the solder points from mechanical strain. All pin headers can be manually coded or ordered pre-coded. HC = High Current.

General ordering data

Type	SL 5.08HC/10/180LF 3.2S...	Version
Order No.	1149490000	PCB plug-in connector, male header, Solder flange, THT solder
GTIN (EAN)	4032248932696	connection, 5.08 mm, Number of poles: 10, 180°, Solder pin length
Qty.	30 ST	(l): 3.2 mm, tinned, black, Box
Type	SL 5.08HC/10/180LF 3.2S...	Version
Order No.	1148150000	PCB plug-in connector, male header, Solder flange, THT solder
GTIN (EAN)	4032248931842	connection, 5.08 mm, Number of poles: 10, 180°, Solder pin length
Qty.	30 ST	(l): 3.2 mm, tinned, orange, Box

BLF 5.08HC/10/90F SN OR BX

Weidmüller Interface GmbH & Co. KG
 Klingenbergstraße 26
 D-32758 Detmold
 Germany

www.weidmueller.com

Counterpart

SL 5.08HC/90F



Pin headers made from glass-fibre-reinforced plastic with 90° wire outlet; optimised for wave soldering. The flange variant (F) can be screwed onto the respective counter piece or the circuit board. There is no need for an extra screw to connect the circuit board when the solder flange (LF) version is used. This also protects the solder points from mechanical strain. All pin headers can be manually coded or ordered pre-coded. HC = High Current.

General ordering data

Type	SL 5.08HC/10/90F 3.2SN ...	Version
Order No.	1150180000	PCB plug-in connector, male header, Flange, THT solder connection,
GTIN (EAN)	4032248936328	5.08 mm, Number of poles: 10, 90°, Solder pin length (l): 3.2 mm,
Qty.	30 ST	tinned, black, Box
Type	SL 5.08HC/10/90F 3.2SN ...	Version
Order No.	1148880000	PCB plug-in connector, male header, Flange, THT solder connection,
GTIN (EAN)	4032248935840	5.08 mm, Number of poles: 10, 90°, Solder pin length (l): 3.2 mm,
Qty.	30 ST	tinned, orange, Box

SL 5.08HC/90LF



Pin headers made from glass-fibre-reinforced plastic with 90° wire outlet; optimised for wave soldering. The flange variant (F) can be screwed onto the respective counter piece or the circuit board. There is no need for an extra screw to connect the circuit board when the solder flange (LF) version is used. This also protects the solder points from mechanical strain. All pin headers can be manually coded or ordered pre-coded. HC = High Current.

General ordering data

Type	SL 5.08HC/10/90LF 3.2SN...	Version
Order No.	1150430000	PCB plug-in connector, male header, Solder flange, THT solder
GTIN (EAN)	4032248937042	connection, 5.08 mm, Number of poles: 10, 90°, Solder pin length (l):
Qty.	30 ST	3.2 mm, tinned, black, Box
Type	SL 5.08HC/10/90LF 3.2SN...	Version
Order No.	1149640000	PCB plug-in connector, male header, Solder flange, THT solder
GTIN (EAN)	4032248936366	connection, 5.08 mm, Number of poles: 10, 90°, Solder pin length (l):
Qty.	30 ST	3.2 mm, tinned, orange, Box

BLF 5.08HC/10/90F SN OR BX

Weidmüller Interface GmbH & Co. KG
 Klingenbergstraße 26
 D-32758 Detmold
 Germany

www.weidmueller.com

Counterpart

SL-SMT 5.08/180F Box



High-temperature-resistant pin header, packed in box or tape. On tape, with 1.5 mm solder pin, optimised for automatic assembly. 3.2 mm solder pin suitable for reflow and wave soldering. The pin headers provide space for labelling and can be coded. HC = High Current.

General ordering data

Type	SL-SMT 5.08HC/10/180F 3...	Version
Order No.	1820780000	PCB plug-in connector, male header, Flange, THT/THR solder
GTIN (EAN)	4032248317646	connection, 5.08 mm, Number of poles: 10, 180°, Solder pin length
Qty.	30 ST	(l): 3.2 mm, tinned, black, Box

SL-SMT 5.08/180LF Box



High-temperature-resistant pin header, packed in box or tape. On tape, with 1.5 mm solder pin, optimised for automatic assembly. 3.2 mm solder pin suitable for reflow and wave soldering. The pin headers provide space for labelling and can be coded. HC = High Current.

General ordering data

Type	SL-SMT 5.08HC/10/180LF ...	Version
Order No.	1776442001	PCB plug-in connector, male header, Solder flange, THT/THR solder
GTIN (EAN)	4032248159321	connection, 5.08 mm, Number of poles: 10, 180°, Solder pin length
Qty.	30 ST	(l): 1.5 mm, tinned, black, Box
Type	SL-SMT 5.08HC/10/180LF ...	Version
Order No.	1838520000	PCB plug-in connector, male header, Solder flange, THT/THR solder
GTIN (EAN)	4032248348589	connection, 5.08 mm, Number of poles: 10, 180°, Solder pin length
Qty.	30 ST	(l): 3.2 mm, tinned, black, Box

SL-SMT 5.08HC/90F Box



High-temperature-resistant pin header, packed in box or tape. On tape, with 1.5 mm solder pin, optimised for automatic assembly. 3.2 mm solder pin suitable for reflow and wave soldering. The pin headers provide space for labelling and can be coded. HC = High Current.

BLF 5.08HC/10/90F SN OR BX

Weidmüller Interface GmbH & Co. KG
 Klingenbergstraße 26
 D-32758 Detmold
 Germany

www.weidmueller.com

Counterpart

General ordering data

Type	SL-SMT 5.08HC/10/90F 3...	Version
Order No.	1837710000	PCB plug-in connector, male header, Flange, THT/THR solder
GTIN (EAN)	4032248347520	connection, 5.08 mm, Number of poles: 10, 90°, Solder pin length (l):
Qty.	30 ST	3.2 mm, tinned, black, Box

SL-SMT 5.08HC/90LF Box



High-temperature-resistant pin header, packed in box or tape. On tape, with 1.5 mm solder pin, optimised for automatic assembly. 3.2 mm solder pin suitable for reflow and wave soldering. The pin headers provide space for labelling and can be coded. HC = High Current.

General ordering data

Type	SL-SMT 5.08HC/10/90LF 1...	Version
Order No.	1775312001	PCB plug-in connector, male header, Solder flange, THT/THR solder
GTIN (EAN)	4032248157297	connection, 5.08 mm, Number of poles: 10, 90°, Solder pin length (l):
Qty.	30 ST	1.5 mm, tinned, black, Box
Type	SL-SMT 5.08HC/10/90LF 3...	Version
Order No.	1780490000	PCB plug-in connector, male header, Solder flange, THT/THR solder
GTIN (EAN)	4032248165810	connection, 5.08 mm, Number of poles: 10, 90°, Solder pin length (l):
Qty.	30 ST	3.2 mm, tinned, black, Box

SLDV-THR 5.08/180F



High-temperature resistant, double level, laterally offset, male connector with flange or solder flange. 1.5 mm solder pin is suitable for reflow soldering. 3.2 mm solder pin suitable for reflow and wave soldering. The pin headers provide space for labelling and can be coded.

General ordering data

Type	SLDV-THR 5.08/20/180F 1...	Version
Order No.	1828970000	PCB plug-in connector, male header, Flange, THT/THR solder
GTIN (EAN)	4032248335664	connection, 5.08 mm, Number of poles: 20, 180°, Solder pin length
Qty.	16 ST	(l): 1.5 mm, tinned, black, Box
Type	SLDV-THR 5.08/20/180F 3...	Version
Order No.	1828850000	PCB plug-in connector, male header, Flange, THT/THR solder
GTIN (EAN)	4032248335541	connection, 5.08 mm, Number of poles: 20, 180°, Solder pin length
Qty.	16 ST	(l): 3.2 mm, tinned, black, Box

BLF 5.08HC/10/90F SN OR BX

Weidmüller Interface GmbH & Co. KG
 Klingenbergstraße 26
 D-32758 Detmold
 Germany

www.weidmueller.com

Counterpart

SLDV-THR 5.08/180FLF



High-temperature resistant, double level, laterally offset, male connector with flange or solder flange. 1.5 mm solder pin is suitable for reflow soldering. 3.2 mm solder pin suitable for reflow and wave soldering. The pin headers provide space for labelling and can be coded.

General ordering data

Type	SLDV-THR 5.08/20/180FLF...	Version
Order No.	1829090000	PCB plug-in connector, male header, Flange / Solder flange, THT/THR
GTIN (EAN)	4032248335787	solder connection, 5.08 mm, Number of poles: 20, 180°, Solder pin
Qty.	16 ST	length (l): 3.2 mm, tinned, black, Box

SLF 5.08/180F SN



Male plug with PUSH IN wire connection and straight outlet direction, when used with BLF 5.08HC as wire-to-wire application for panel feed-through. The male plugs provide space for labelling and can be coded.

General ordering data

Type	SLF 5.08/10/180F SN BK ...	Version
Order No.	1336250000	PCB plug-in connector, male plug, 5.08 mm, Number of poles: 10,
GTIN (EAN)	4050118140064	180°, PUSH IN with actuator, Clamping range, max. : 3.31 mm², Box
Qty.	30 ST	
Type	SLF 5.08/10/180F SN OR ...	Version
Order No.	1335760000	PCB plug-in connector, male plug, 5.08 mm, Number of poles: 10,
GTIN (EAN)	4050118139273	180°, PUSH IN with actuator, Clamping range, max. : 3.31 mm², Box
Qty.	30 ST	

SLF 5.08/180FI SN

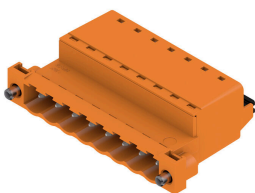

Male plug with PUSH IN wire connection and straight outlet direction, when used with BLF 5.08HC as wire-to-wire application for panel feed-through. The male plugs provide space for labelling and can be coded.

BLF 5.08HC/10/90F SN OR BX

Weidmüller Interface GmbH & Co. KG
 Klingenbergstraße 26
 D-32758 Detmold
 Germany

Counterpart

www.weidmueller.com

General ordering data

Type	SLF 5.08/10/180FI SN BK...	Version
Order No.	1336130000	PCB plug-in connector, male plug, 5.08 mm, Number of poles: 10,
GTIN (EAN)	4050118140040	180°, PUSH IN with actuator, Clamping range, max. : 3.31 mm², Box
Qty.	30 ST	
Type	SLF 5.08/10/180FI SN OR...	Version
Order No.	1336490000	PCB plug-in connector, male plug, 5.08 mm, Number of poles: 10,
GTIN (EAN)	4050118140279	180°, PUSH IN with actuator, Clamping range, max. : 3.31 mm², Box
Qty.	30 ST	

SLS 5.08/180F



Male plugs with clamping-yoke screw wire-connect system. The male plugs provide space for labelling and can be coded.

General ordering data

Type	SLS 5.08/10/180F SN OR ...	Version
Order No.	1846440000	PCB plug-in connector, male plug, 5.08 mm, Number of poles: 10,
GTIN (EAN)	4032248362745	180°, Clamping yoke connection, Clamping range, max. : 3.31 mm²,
Qty.	30 ST	Box

SLS 5.08/180FI

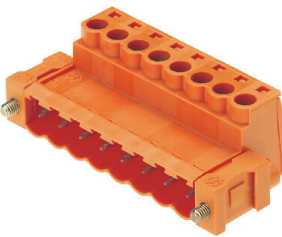

Male plugs with clamping-yoke screw wire-connect system. The male plugs provide space for labelling and can be coded.

General ordering data

Type	SLS 5.08/10/180FI SN OR...	Version
Order No.	1846290000	PCB plug-in connector, male plug, 5.08 mm, Number of poles: 10,
GTIN (EAN)	4032248362578	180°, Clamping yoke connection, Clamping range, max. : 3.31 mm²,
Qty.	30 ST	Box