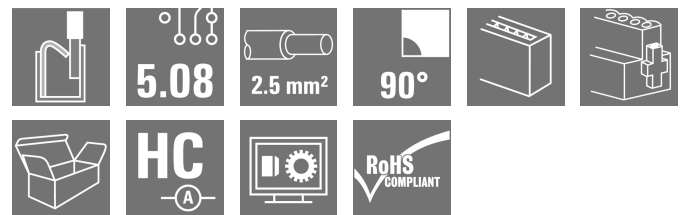
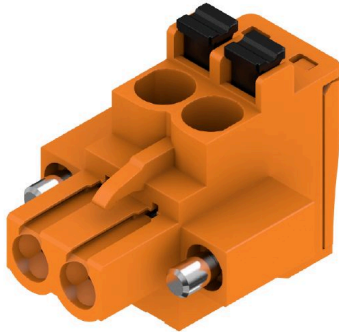

BLF 5.08HC/02/90F SN OR BX
Weidmüller Interface GmbH & Co. KG

 Klingenbergstraße 26
 D-32758 Detmold
 Germany

www.weidmueller.com
Product image

Just as reliable as the millionfold proven original and featuring innovative details:

The BLF 5.08HC PUSH IN version of the BLZP 5.08HC female connector is not only different in terms of connection system; it also has a more compact design. Weidmüller's innovative PUSH IN spring connection system stands for the future of easy and tool-free wire connection. HC = High Current.

In terms of versatility, the BLF 5.08HC offers just as much as the version which served as a model:

- 3 tested-and-proven wire outlet directions provide the usual flexibility for application-specific design
- 4 flange variations and the patented release latch allow the locking concept to be based on the requirements of the user
- Use the BLF 5.08HC and SL 5.08HC plug combination to reach the max. rated specifications

General ordering data

Version	PCB plug-in connector, female plug, 5.08 mm, Number of poles: 2, 90°, PUSH IN with actuator, Clamping range, max.: 3.31 mm², Box
Order No.	1002090000
Type	BLF 5.08HC/02/90F SN OR BX
GTIN (EAN)	4032248694044
Qty.	90 items
Product data	IEC: 400 V / 24 A / 0.2 - 2.5 mm² UL: 300 V / 18.5 A / AWG 26 - AWG 12
Packaging	Box

BLF 5.08HC/02/90F SN OR BX

Weidmüller Interface GmbH & Co. KG
 Klingenbergstraße 26
 D-32758 Detmold
 Germany

www.weidmueller.com

Technical data

Approvals

Approvals



ROHS	Conform
UL File Number Search	UL Website
Certificate No. (cURus)	E60693

Dimensions and weights

Depth	26.2 mm	Depth (inches)	1.0315 inch
Height	20.6 mm	Height (inches)	0.811 inch
Width	19.96 mm	Width (inches)	0.7858 inch
Net weight	5.25 g		

Environmental Product Compliance

RoHS Compliance Status	Compliant without exemption
REACH SVHC	No SVHC above 0.1 wt%

System Parameters

Product family	OMNIMATE Signal - series BL/SL 5.08		
Type of connection	Field connection		
Wire connection method	PUSH IN with actuator		
Pitch in mm (P)	5.08 mm		
Pitch in inches (P)	0.200 "		
Conductor outlet direction	90°		
Number of poles	2		
L1 in mm	5.08 mm		
L1 in inches	0.200 "		
Number of rows	1		
Pin series quantity	1		
Rated cross-section	2.5 mm ²		
Touch-safe protection acc. to DIN VDE 57 106	Safe from finger touch		
Touch-safe protection acc. to DIN VDE 0470	IP20 plugged/ IP10 unplugged		
Protection degree	IP20		
Volume resistance	≤5 mΩ		
Can be coded	Yes		
Stripping length	10 mm		
Screwdriver blade	0.6 x 3.5		
Screwdriver blade standard	DIN 5264		
Plugging cycles	25		
Plugging force/pole, max.	7 N		
Pulling force/pole, max.	5.5 N		
Tightening torque	Torque type	Screw flange	
	Usage information	Tightening torque	min. 0.2 Nm max. 0.25 Nm

Material data

Insulating material	PBT	Colour	orange
Colour chart (similar)	RAL 2000	Insulating material group	IIIa

BLF 5.08HC/02/90F SN OR BX

Weidmüller Interface GmbH & Co. KG
 Klingenbergstraße 26
 D-32758 Detmold
 Germany

www.weidmueller.com

Technical data

Comparative Tracking Index (CTI)	≥ 200	Moisture Level (MSL)	
UL 94 flammability rating	V-0	Contact material	Cu-alloy
Contact surface	tinned	Layer structure of plug contact	4...8 µm Sn hot-dip tinned
Storage temperature, min.	-40 °C	Storage temperature, max.	70 °C
Operating temperature, min.	-50 °C	Operating temperature, max.	100 °C
Temperature range, installation, min.	-30 °C	Temperature range, installation, max.	100 °C

Conductors suitable for connection

Clamping range, min.	0.13 mm ²
Clamping range, max.	3.31 mm ²
Wire connection cross section AWG, min.	AWG 26
Wire connection cross section AWG, max.	AWG 12
Solid, min. H05(07) V-U	0.2 mm ²
Solid, max. H05(07) V-U	2.5 mm ²
Flexible, min. H05(07) V-K	0.2 mm ²
Flexible, max. H05(07) V-K	2.5 mm ²
w. plastic collar ferrule, DIN 46228 pt 4, min.	0.25 mm ²
w. plastic collar ferrule, DIN 46228 pt 4, max.	2.5 mm ²
w. wire end ferrule, DIN 46228 pt 1, min.	0.25 mm ²
w. wire end ferrule, DIN 46228 pt 1, max.	2.5 mm ²
Plug gauge in accordance with EN 60999 a x b; ø	2.8 mm x 2.0 mm

Clampable conductor	Cross-section for conductor connection	Type	fine-wired
		nominal	0.5 mm ²
wire end ferrule		Stripping length	nominal 12 mm
		Recommended wire-end ferrule	H0.5/16 OR
		Stripping length	nominal 10 mm
		Recommended wire-end ferrule	H0.5/10
Cross-section for conductor connection		Type	fine-wired
		nominal	0.75 mm ²
		Stripping length	nominal 12 mm
		Recommended wire-end ferrule	H0.75/16 W
wire end ferrule		Stripping length	nominal 10 mm
		Recommended wire-end ferrule	H0.75/10
		Stripping length	nominal 12 mm
		Recommended wire-end ferrule	H1.0/16D R
Cross-section for conductor connection		Type	fine-wired
		nominal	1 mm ²
		Stripping length	nominal 12 mm
		Recommended wire-end ferrule	H1.0/10
wire end ferrule		Stripping length	nominal 10 mm
		Recommended wire-end ferrule	H1.5/10
		Stripping length	nominal 12 mm
		Recommended wire-end ferrule	H1.5/10

BLF 5.08HC/02/90F SN OR BX

Weidmüller Interface GmbH & Co. KG
 Klingenbergstraße 26
 D-32758 Detmold
 Germany

www.weidmueller.com

Technical data

		Recommended wire-end ferrule	H1.5/16 R
Cross-section for conductor connection	Type	fine-wired	
	nominal	2.5 mm ²	
wire end ferrule	Stripping length	nominal	10 mm
	Recommended wire-end ferrule	H2.5/10	
	Stripping length	nominal	13 mm
	Recommended wire-end ferrule	H2.5/16DS BL	
Reference text	The outside diameter of the plastic collar should not be larger than the pitch (P), Length of ferrules is to be chosen depending on the product and the rated voltage.		

Rated data acc. to IEC

tested acc. to standard	IEC 60664-1, IEC 61984	Rated current, min. number of poles (Tu=20°C)	24 A
Rated current, max. number of poles (Tu=20°C)	19 A	Rated current, min. number of poles (Tu=40°C)	21 A
Rated current, max. number of poles (Tu=40°C)	16.5 A	Rated voltage for surge voltage class / pollution degree II/2	400 V
Rated voltage for surge voltage class / pollution degree III/2	320 V	Rated voltage for surge voltage class / pollution degree III/3	250 V
Rated impulse voltage for surge voltage class/ pollution degree II/2	4 kV	Rated impulse voltage for surge voltage class/ pollution degree III/2	4 kV
Rated impulse voltage for surge voltage class/ contamination degree III/3	4 kV	Short-time withstand current resistance	3 x 1s with 120 A

Rated data acc. to CSA

Institute (CSA)	CSA	Certificate No. (CSA)	200039-1121690
Rated voltage (Use group B / CSA)	300 V	Rated voltage (Use group D / CSA)	300 V
Rated current (Use group B / CSA)	10 A	Rated current (Use group D / CSA)	10 A
Wire cross-section, AWG, min.	AWG 12	Wire cross-section, AWG, max.	AWG 26
Reference to approval values	Specifications are maximum values, details - see approval certificate.		

Rated data acc. to UL 1059

Institute (cURus)	CURUS	Certificate No. (cURus)	E60693
Rated voltage (Use group B / UL 1059)	300 V	Rated voltage (Use group D / UL 1059)	300 V
Rated current (Use group B / UL 1059)	18.5 A	Rated current (Use group D / UL 1059)	10 A
Wire cross-section, AWG, min.	AWG 26	Wire cross-section, AWG, max.	AWG 12
Reference to approval values	Specifications are maximum values, details - see approval certificate.		

Packing

Packaging	Box	VPE length	347.00 mm
VPE width	135.00 mm	VPE height	33.00 mm

Type tests

Test: Durability of markings	Standard	DIN EN 61984 section 7.3.2 / 09.02 taking pattern from DIN EN 60068-2-70 / 07.96
	Test	mark of origin, type identification, pitch, type of material, date clock
	Evaluation	available

BLF 5.08HC/02/90F SN OR BX

Weidmüller Interface GmbH & Co. KG
 Klingenbergstraße 26
 D-32758 Detmold
 Germany

www.weidmueller.com

Technical data

	Test	durability	
	Evaluation	passed	
Test: Misengagement (Non-interchangeability)	Standard	DIN EN 61984 section 6.3 and 6.9.1 / 09.02, DIN EN 60512-13-5 / 11.08	
	Test	180° turned with coding elements	
	Evaluation	passed	
	Test	visual examination	
	Evaluation	passed	
Test: Clampable cross section	Standard	DIN EN 60999-1 section 7 and 9.1 / 12.00, DIN EN 60947-1 section 8.2.4.5.1 / 04.08	
	Conductor type	Type of conductor and conductor cross-section	solid 0.2 mm ²
		Type of conductor and conductor cross-section	stranded 0.2 mm ²
		Type of conductor and conductor cross-section	solid 2.5 mm ²
		Type of conductor and conductor cross-section	stranded 2.5 mm ²
		Type of conductor and conductor cross-section	AWG 26/1
		Type of conductor and conductor cross-section	AWG 26/19
		Type of conductor and conductor cross-section	AWG 14/1
		Type of conductor and conductor cross-section	AWG 14/19
	Evaluation	passed	
Test for damage to and accidental loosening of conductors	Standard	DIN EN 60999-1 section 9.4 / 12.00	
	Requirement	0.2 kg	
	Conductor type	Type of conductor and conductor cross-section	AWG 26/1
		Type of conductor and conductor cross-section	AWG 26/19
	Evaluation	passed	
	Requirement	0.3 kg	
	Conductor type	Type of conductor and conductor cross-section	H05V-U0.5
		Type of conductor and conductor cross-section	H05V-K0.5
	Evaluation	passed	
	Requirement	0.7 kg	
Conductor type	Type of conductor and conductor cross-section	H07V-U2.5	
	Type of conductor and conductor cross-section	H07V-K2.5	
Evaluation	passed		
Requirement	0.9 kg		

BLF 5.08HC/02/90F SN OR BX

Weidmüller Interface GmbH & Co. KG
 Klingenbergstraße 26
 D-32758 Detmold
 Germany

www.weidmueller.com

Technical data

Pull-out test	Conductor type	Type of conductor and conductor cross-section	AWG 12/1
		Type of conductor and conductor cross-section	AWG 12/19
	Evaluation	passed	
	Standard	DIN EN 60999-1 section 9.5 / 12.00	
	Requirement	≥10 N	
	Conductor type	Type of conductor and conductor cross-section	AWG 26/1
		Type of conductor and conductor cross-section	AWG 26/19
	Evaluation	passed	
	Requirement	≥20 N	
	Conductor type	Type of conductor and conductor cross-section	H05V-U0.5
		Type of conductor and conductor cross-section	H05V-K0.5
	Evaluation	passed	
Requirement	≥50 N		
Conductor type	Type of conductor and conductor cross-section	H07V-U2.5	
	Type of conductor and conductor cross-section	H07V-K2.5	
Evaluation	passed		
Requirement	≥60 N		
Conductor type	Type of conductor and conductor cross-section	AWG 12/1	
	Type of conductor and conductor cross-section	AWG 12/19	
Evaluation	passed		

Important note

IPC conformity Conformity: The products are developed, manufactured and delivered according international recognized standards and norms and comply with the assured properties in the data sheet resp. fulfill decorative properties in accordance with IPC-A-610 "Class 2". Further claims on the products can be evaluated on request.

- Notes**
- Additional variants on request
 - Gold-plated contact surfaces on request
 - Rated current related to rated cross-section & min. No. of poles.
 - Wire end ferrule without plastic collar to DIN 46228/1
 - Wire end ferrule with plastic collar to DIN 46228/4
 - P on drawing = pitch
 - Crimping shape "A" for wire end ferrules with PZ 6/5 crimping tool recommended.
 - The test point can only be used as potential-pickup point.
 - In accordance with IEC 61984, OMNIMATE-connectors are connectors without breaking capacity (COC). During designated use, connectors are not allowed to be engaged or disengaged when live or under load
 - Long term storage of the product with average temperature of 50 °C and maximum humidity 70%, 36 months

BLF 5.08HC/02/90F SN OR BX

Weidmüller Interface GmbH & Co. KG
Klingenbergstraße 26
D-32758 Detmold
Germany

Technical data

www.weidmueller.com

Classifications

ETIM 6.0	EC002638	ETIM 7.0	EC002638
ETIM 8.0	EC002638	ETIM 9.0	EC002638
ETIM 10.0	EC002638	ECLASS 9.0	27-44-03-09
ECLASS 9.1	27-44-03-09	ECLASS 10.0	27-44-03-09
ECLASS 11.0	27-46-02-02	ECLASS 12.0	27-46-02-02
ECLASS 13.0	27-46-02-02	ECLASS 14.0	27-46-02-02
ECLASS 15.0	27-46-02-02		

BLF 5.08HC/02/90F SN OR BX

Weidmüller Interface GmbH & Co. KG
 Klingenbergstraße 26
 D-32758 Detmold
 Germany

Drawings

www.weidmueller.com

Product image



Dimensional drawing

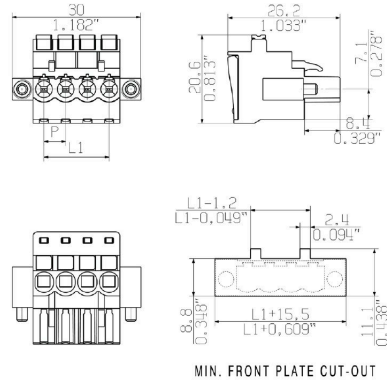

Graph

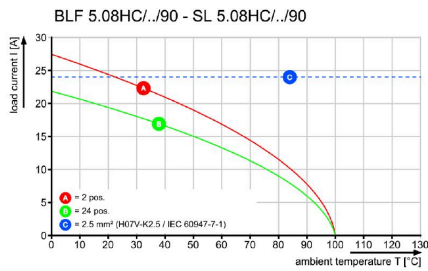

Graph

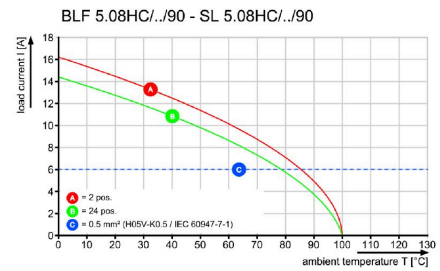

Uncompromising functionality High vibration resistance

Drawings

Product benefits



Solid PUSH IN contact
Safe and durable

Product benefits

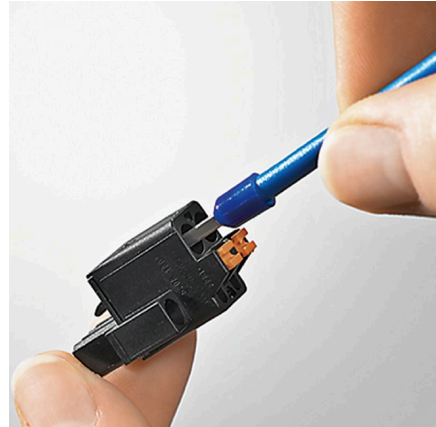

Cost-effective wiring
Quick and intuitive operation

Product benefits



Wide clamping range
Tool-free wire connection

BLF 5.08HC/02/90F SN OR BX

Weidmüller Interface GmbH & Co. KG
 Klingenbergstraße 26
 D-32758 Detmold
 Germany

www.weidmueller.com

Accessories

Coding elements



Only connects what is supposed to be connected: the right connection at the right place.
 Coding elements and locking devices clearly assign connecting elements during the manufacturing process and operation
 The coding elements and locking devices are inserted prior to assembly or during the cable assembly phase. The Weidmüller alternative: configure online using the variant configurator to precode prior to delivery. Incorrect assembly on the circuit board and incorrect plugging of connecting elements is no longer possible. The advantage: no troubleshooting during manufacture and no operational errors by the user.

General ordering data

Type	BLZ/SL KO BK BX	Version
Order No.	1545710000	PCB plug-in connector, Accessories, Coding element, black, Number of poles: 1
GTIN (EAN)	4008190087142	
Qty.	50 ST	
Type	BLZ/SL KO OR BX	Version
Order No.	1573010000	PCB plug-in connector, Accessories, Coding element, orange, Number of poles: 1
GTIN (EAN)	4008190048396	
Qty.	100 ST	

Slotted screwdriver

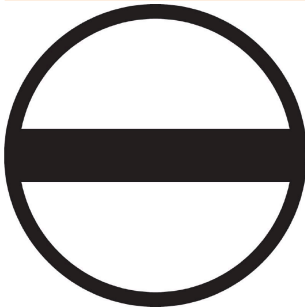

Slotted screwdriver with rounded blade SD DIN 5265, ISO 2380/2, output to DIN 5264, ISO 2380/1. ChromTop tip, SoftFinish grip

General ordering data

Type	SDS 0.6X3.5X100	Version
Order No.	2749340000	Screwdriver, Blade width (B): 3.5 mm, Blade length: 100 mm, Blade thickness (A): 0.6 mm
GTIN (EAN)	4050118895568	
Qty.	1 ST	
Type	SDS 0.6X3.5X200	Version
Order No.	9010110000	Screwdriver, Screwdriver
GTIN (EAN)	4032248300754	
Qty.	1 ST	
Type	SDIS 0.6X3.5X100	Version
Order No.	2749810000	Screwdriver, Blade width (B): 3.5 mm, Blade length: 100 mm, Blade thickness (A): 0.6 mm
GTIN (EAN)	4050118897012	
Qty.	1 ST	

BLF 5.08HC/02/90F SN OR BX

Weidmüller Interface GmbH & Co. KG
Klingenbergstraße 26
D-32758 Detmold
Germany

Counterpart

www.weidmueller.com

SL 5.08HC/180F

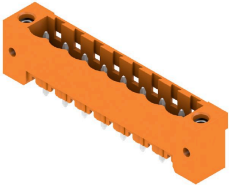

Pin headers in glass-fibre-reinforced plastic with straight wire outlet; optimised for wave soldering. The flange variant (F) can be screwed onto the respective counter piece or the circuit board. There is no need for an extra screw to connect the circuit board when the solder flange (LF) version is used. This also protects the solder points from mechanical strain. All pin headers can be manually coded or ordered pre-coded. HC = High Current.

General ordering data

Type	SL 5.08HC/02/180F 3.2SN...	Version
Order No.	1148490000	PCB plug-in connector, male header, Flange, THT solder connection,
GTIN (EAN)	4032248931507	5.08 mm, Number of poles: 2, 180°, Solder pin length (l): 3.2 mm,
Qty.	90 ST	tinned, black, Box
Type	SL 5.08HC/02/180F 3.2SN...	Version
Order No.	1147130000	PCB plug-in connector, male header, Flange, THT solder connection,
GTIN (EAN)	4032248931040	5.08 mm, Number of poles: 2, 180°, Solder pin length (l): 3.2 mm,
Qty.	90 ST	tinned, orange, Box

SL 5.08HC/180LF

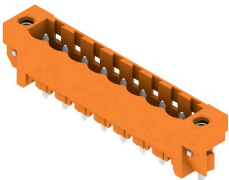

Pin headers in glass-fibre-reinforced plastic with straight wire outlet; optimised for wave soldering. The flange variant (F) can be screwed onto the respective counter piece or the circuit board. There is no need for an extra screw to connect the circuit board when the solder flange (LF) version is used. This also protects the solder points from mechanical strain. All pin headers can be manually coded or ordered pre-coded. HC = High Current.

General ordering data

Type	SL 5.08HC/02/180LF 3.2S...	Version
Order No.	1149220000	PCB plug-in connector, male header, Solder flange, THT solder
GTIN (EAN)	4032248932603	connection, 5.08 mm, Number of poles: 2, 180°, Solder pin length (l):
Qty.	90 ST	3.2 mm, tinned, black, Box
Type	SL 5.08HC/02/180LF 3.2S...	Version
Order No.	1147890000	PCB plug-in connector, male header, Solder flange, THT solder
GTIN (EAN)	4032248931804	connection, 5.08 mm, Number of poles: 2, 180°, Solder pin length (l):
Qty.	90 ST	3.2 mm, tinned, orange, Box

BLF 5.08HC/02/90F SN OR BX

Weidmüller Interface GmbH & Co. KG
Klingenbergstraße 26
D-32758 Detmold
Germany

Counterpart

www.weidmueller.com

SL 5.08HC/90F

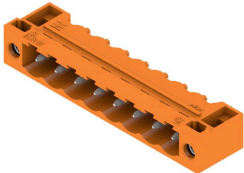

Pin headers made from glass-fibre-reinforced plastic with 90° wire outlet; optimised for wave soldering. The flange variant (F) can be screwed onto the respective counter piece or the circuit board. There is no need for an extra screw to connect the circuit board when the solder flange (LF) version is used. This also protects the solder points from mechanical strain. All pin headers can be manually coded or ordered pre-coded. HC = High Current.

General ordering data

Type	SL 5.08HC/02/90F 3.2SN ...	Version
Order No.	1150090000	PCB plug-in connector, male header, Flange, THT solder connection,
GTIN (EAN)	4032248936960	5.08 mm, Number of poles: 2, 90°, Solder pin length (l): 3.2 mm,
Qty.	90 ST	tinned, black, Box
Type	SL 5.08HC/02/90F 3.2SN ...	Version
Order No.	1148610000	PCB plug-in connector, male header, Flange, THT solder connection,
GTIN (EAN)	4032248935680	5.08 mm, Number of poles: 2, 90°, Solder pin length (l): 3.2 mm,
Qty.	90 ST	tinned, orange, Box

SL 5.08HC/90LF

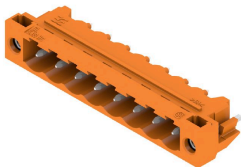

Pin headers made from glass-fibre-reinforced plastic with 90° wire outlet; optimised for wave soldering. The flange variant (F) can be screwed onto the respective counter piece or the circuit board. There is no need for an extra screw to connect the circuit board when the solder flange (LF) version is used. This also protects the solder points from mechanical strain. All pin headers can be manually coded or ordered pre-coded. HC = High Current.

General ordering data

Type	SL 5.08HC/02/90LF 3.2SN...	Version
Order No.	1150340000	PCB plug-in connector, male header, Solder flange, THT solder
GTIN (EAN)	4032248936304	connection, 5.08 mm, Number of poles: 2, 90°, Solder pin length (l):
Qty.	90 ST	3.2 mm, tinned, black, Box
Type	SL 5.08HC/02/90LF 3.2SN...	Version
Order No.	1149380000	PCB plug-in connector, male header, Solder flange, THT solder
GTIN (EAN)	4032248935864	connection, 5.08 mm, Number of poles: 2, 90°, Solder pin length (l):
Qty.	90 ST	3.2 mm, tinned, orange, Box

BLF 5.08HC/02/90F SN OR BX

Weidmüller Interface GmbH & Co. KG
 Klingenbergstraße 26
 D-32758 Detmold
 Germany

Counterpart

www.weidmueller.com

SL-SMT 5.08/180F Box



High-temperature-resistant pin header, packed in box or tape. On tape, with 1.5 mm solder pin, optimised for automatic assembly. 3.2 mm solder pin suitable for reflow and wave soldering. The pin headers provide space for labelling and can be coded. HC = High Current.

General ordering data

Type	SL-SMT 5.08HC/02/180F 1...	Version
Order No.	1837320000	PCB plug-in connector, male header, Flange, THT/THR solder connection, 5.08 mm, Number of poles: 2, 180°, Solder pin length (l):
GTIN (EAN)	4032248345915	
Qty.	90 ST	1.5 mm, tinned, black, Box
Type	SL-SMT 5.08HC/02/180F 3...	Version
Order No.	1837860000	PCB plug-in connector, male header, Flange, THT/THR solder connection, 5.08 mm, Number of poles: 2, 180°, Solder pin length (l):
GTIN (EAN)	4032248347674	
Qty.	90 ST	3.2 mm, tinned, black, Box

SL-SMT 5.08/180LF Box

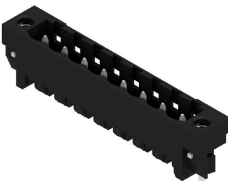

High-temperature-resistant pin header, packed in box or tape. On tape, with 1.5 mm solder pin, optimised for automatic assembly. 3.2 mm solder pin suitable for reflow and wave soldering. The pin headers provide space for labelling and can be coded. HC = High Current.

General ordering data

Type	SL-SMT 5.08HC/02/180LF ...	Version
Order No.	1776362001	PCB plug-in connector, male header, Solder flange, THT/THR solder connection, 5.08 mm, Number of poles: 2, 180°, Solder pin length (l):
GTIN (EAN)	4032248159147	
Qty.	90 ST	1.5 mm, tinned, black, Box
Type	SL-SMT 5.08HC/02/180LF ...	Version
Order No.	1838440000	PCB plug-in connector, male header, Solder flange, THT/THR solder connection, 5.08 mm, Number of poles: 2, 180°, Solder pin length (l):
GTIN (EAN)	4032248348503	
Qty.	90 ST	3.2 mm, tinned, black, Box

BLF 5.08HC/02/90F SN OR BX

Weidmüller Interface GmbH & Co. KG
Klingenbergstraße 26
D-32758 Detmold
Germany

www.weidmueller.com

Counterpart

SL-SMT 5.08/180LF Tape



High-temperature-resistant pin header, packed in box or tape. On tape, with 1.5 mm solder pin, optimised for automatic assembly. 3.2 mm solder pin suitable for reflow and wave soldering. The pin headers provide space for labelling and can be coded. HC = High Current.

General ordering data

Type	SL-SMT 5.08HC/02/180LF ...	Version
Order No.	1776364001	PCB plug-in connector, male header, Solder flange, THT/THR solder
GTIN (EAN)	4032248163472	connection, 5.08 mm, Number of poles: 2, 180°, Solder pin length (l):
Qty.	250 ST	1.5 mm, tinned, black, Tape

SL-SMT 5.08/270FH Box

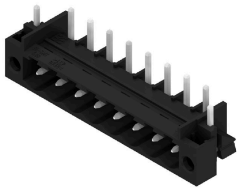

High-temperature-resistant, straight, open pin header. Packed in box or tape. On tape and with 1.5 mm solder pin, optimised for automatic assembly. 3.2 mm solder pin suitable for reflow and wave soldering. The pin headers provide space for labelling and can be coded. HC = High Current.

General ordering data

Type	SL-SMT 5.08HC/02/270FH ...	Version
Order No.	1877190000	PCB plug-in connector, male header, Solder flange, THT/THR solder
GTIN (EAN)	4032248467754	connection, 5.08 mm, Number of poles: 2, 270°, Solder pin length (l):
Qty.	100 ST	3.2 mm, tinned, black, Box

SL-SMT 5.08/270FH Tape



High-temperature-resistant, straight, open pin header. Packed in box or tape. On tape and with 1.5 mm solder pin, optimised for automatic assembly. 3.2 mm solder pin suitable for reflow and wave soldering. The pin headers provide space for labelling and can be coded. HC = High Current.

General ordering data

Type	SL-SMT 5.08HC/02/270FH ...	Version
Order No.	1876920000	PCB plug-in connector, male header, Solder flange, THT/THR solder
GTIN (EAN)	4032248467501	connection, 5.08 mm, Number of poles: 2, 270°, Solder pin length (l):
Qty.	335 ST	1.5 mm, tinned, black, Tape

BLF 5.08HC/02/90F SN OR BX

Weidmüller Interface GmbH & Co. KG
 Klingenbergstraße 26
 D-32758 Detmold
 Germany

www.weidmueller.com

Counterpart

SL-SMT 5.08/270FL Box



High-temperature-resistant, straight, open pin header. Packed in box or tape. On tape and with 1.5 mm solder pin, optimised for automatic assembly. 3.2 mm solder pin suitable for reflow and wave soldering. The pin headers provide space for labelling and can be coded. HC = High Current.

General ordering data

Type	SL-SMT 5.08HC/02/270FL ...	Version
Order No.	1876850000	PCB plug-in connector, male header, Solder flange, THT/THR solder
GTIN (EAN)	4032248467679	connection, 5.08 mm, Number of poles: 2, 270°, Solder pin length (l):
Qty.	100 ST	3.2 mm, tinned, black, Box

SL-SMT 5.08/270FL Tape

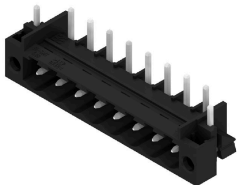

High-temperature-resistant, straight, open pin header. Packed in box or tape. On tape and with 1.5 mm solder pin, optimised for automatic assembly. 3.2 mm solder pin suitable for reflow and wave soldering. The pin headers provide space for labelling and can be coded. HC = High Current.

General ordering data

Type	SL-SMT 5.08HC/02/270FL ...	Version
Order No.	1876990000	PCB plug-in connector, male header, Solder flange, THT/THR solder
GTIN (EAN)	4032248467648	connection, 5.08 mm, Number of poles: 2, 270°, Solder pin length (l):
Qty.	350 ST	1.5 mm, tinned, black, Tape
Type	SL-SMT 5.08HC/02/270FL ...	Version
Order No.	1876730000	PCB plug-in connector, male header, Solder flange, THT/THR solder
GTIN (EAN)	4032248467242	connection, 5.08 mm, Number of poles: 2, 270°, Solder pin length (l):
Qty.	350 ST	3.2 mm, tinned, black, Tape

SL-SMT 5.08HC/90F Box



High-temperature-resistant pin header, packed in box or tape. On tape, with 1.5 mm solder pin, optimised for automatic assembly. 3.2 mm solder pin suitable for reflow and wave soldering. The pin headers provide space for labelling and can be coded. HC = High Current.

BLF 5.08HC/02/90F SN OR BX

Weidmüller Interface GmbH & Co. KG
 Klingenbergstraße 26
 D-32758 Detmold
 Germany

www.weidmueller.com

Counterpart

General ordering data

Type	SL-SMT 5.08HC/02/90F 3...	Version
Order No.	1837630000	PCB plug-in connector, male header, Flange, THT/THR solder
GTIN (EAN)	4032248347445	connection, 5.08 mm, Number of poles: 2, 90°, Solder pin length (l):
Qty.	90 ST	3.2 mm, tinned, black, Box

SL-SMT 5.08HC/90LF Box



High-temperature-resistant pin header, packed in box or tape. On tape, with 1.5 mm solder pin, optimised for automatic assembly. 3.2 mm solder pin suitable for reflow and wave soldering. The pin headers provide space for labelling and can be coded. HC = High Current.

General ordering data

Type	SL-SMT 5.08HC/02/90LF 1...	Version
Order No.	1775232001	PCB plug-in connector, male header, Solder flange, THT/THR solder
GTIN (EAN)	4032248157211	connection, 5.08 mm, Number of poles: 2, 90°, Solder pin length (l):
Qty.	90 ST	1.5 mm, tinned, black, Box
Type	SL-SMT 5.08HC/02/90LF 3...	Version
Order No.	1780410000	PCB plug-in connector, male header, Solder flange, THT/THR solder
GTIN (EAN)	4032248165735	connection, 5.08 mm, Number of poles: 2, 90°, Solder pin length (l):
Qty.	90 ST	3.2 mm, tinned, black, Box

SL-SMT 5.08HC/90LF Tape



High-temperature-resistant pin header, packed in box or tape. On tape, with 1.5 mm solder pin, optimised for automatic assembly. 3.2 mm solder pin suitable for reflow and wave soldering. The pin headers provide space for labelling and can be coded. HC = High Current.

General ordering data

Type	SL-SMT 5.08HC/02/90LF 1...	Version
Order No.	1775234001	PCB plug-in connector, male header, Solder flange, THT/THR solder
GTIN (EAN)	4032248167784	connection, 5.08 mm, Number of poles: 2, 90°, Solder pin length (l):
Qty.	350 ST	1.5 mm, tinned, black, Tape

BLF 5.08HC/02/90F SN OR BX

Weidmüller Interface GmbH & Co. KG
 Klingenbergstraße 26
 D-32758 Detmold
 Germany

www.weidmueller.com

Counterpart

SLDV-THR 5.08/180F



High-temperature resistant, double level, laterally offset, male connector with flange or solder flange. 1.5 mm solder pin is suitable for reflow soldering. 3.2 mm solder pin suitable for reflow and wave soldering. The pin headers provide space for labelling and can be coded.

General ordering data

Type	SLDV-THR 5.08/04/180F 1...	Version
Order No.	1828890000	PCB plug-in connector, male header, Flange, THT/THR solder
GTIN (EAN)	4032248335589	connection, 5.08 mm, Number of poles: 4, 180°, Solder pin length (l):
Qty.	52 ST	1.5 mm, tinned, black, Box
Type	SLDV-THR 5.08/04/180F 3...	Version
Order No.	1828770000	PCB plug-in connector, male header, Flange, THT/THR solder
GTIN (EAN)	4032248335442	connection, 5.08 mm, Number of poles: 4, 180°, Solder pin length (l):
Qty.	52 ST	3.2 mm, tinned, black, Box

SLDV-THR 5.08/180FLF



High-temperature resistant, double level, laterally offset, male connector with flange or solder flange. 1.5 mm solder pin is suitable for reflow soldering. 3.2 mm solder pin suitable for reflow and wave soldering. The pin headers provide space for labelling and can be coded.

General ordering data

Type	SLDV-THR 5.08/04/180FLF...	Version
Order No.	1829010000	PCB plug-in connector, male header, Flange / Solder flange, THT/THR
GTIN (EAN)	4032248335701	solder connection, 5.08 mm, Number of poles: 4, 180°, Solder pin
Qty.	52 ST	length (l): 3.2 mm, tinned, black, Box

SLF 5.08/180F SN

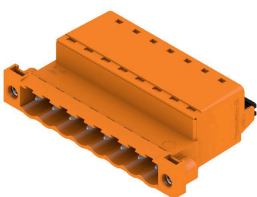

Male plug with PUSH IN wire connection and straight outlet direction, when used with BLF 5.08HC as wire-to-wire application for panel feed-through The male plugs provide space for labelling and can be coded.

BLF 5.08HC/02/90F SN OR BX

Weidmüller Interface GmbH & Co. KG
 Klingenbergstraße 26
 D-32758 Detmold
 Germany

www.weidmueller.com

Counterpart

General ordering data

Type	SLF 5.08/02/180F SN BK ...	Version
Order No.	1336170000	PCB plug-in connector, male plug, 5.08 mm, Number of poles: 2,
GTIN (EAN)	4050118140026	180°, PUSH IN with actuator, Clamping range, max. : 3.31 mm ² , Box
Qty.	90 ST	
Type	SLF 5.08/02/180F SN OR ...	Version
Order No.	1335590000	PCB plug-in connector, male plug, 5.08 mm, Number of poles: 2,
GTIN (EAN)	4050118139242	180°, PUSH IN with actuator, Clamping range, max. : 3.31 mm ² , Box
Qty.	90 ST	

SLF 5.08/180FI SN

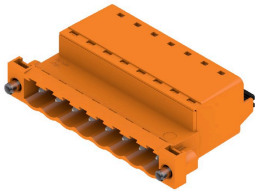

Male plug with PUSH IN wire connection and straight outlet direction, when used with BLF 5.08HC as wire-to-wire application for panel feed-through. The male plugs provide space for labelling and can be coded.

General ordering data

Type	SLF 5.08/02/180FI SN BK...	Version
Order No.	1336040000	PCB plug-in connector, male plug, 5.08 mm, Number of poles: 2,
GTIN (EAN)	4050118139600	180°, PUSH IN with actuator, Clamping range, max. : 3.31 mm ² , Box
Qty.	90 ST	
Type	SLF 5.08/02/180FI SN OR...	Version
Order No.	1336400000	PCB plug-in connector, male plug, 5.08 mm, Number of poles: 2,
GTIN (EAN)	4050118140293	180°, PUSH IN with actuator, Clamping range, max. : 3.31 mm ² , Box
Qty.	90 ST	

SLS 5.08/180F



Male plugs with clamping-yoke screw wire-connect system. The male plugs provide space for labelling and can be coded.

General ordering data

Type	SLS 5.08/02/180F SN OR ...	Version
Order No.	1846360000	PCB plug-in connector, male plug, 5.08 mm, Number of poles: 2,
GTIN (EAN)	4032248362066	180°, Clamping yoke connection, Clamping range, max. : 3.31 mm ² ,
Qty.	90 ST	Box

BLF 5.08HC/02/90F SN OR BX

Weidmüller Interface GmbH & Co. KG
Klingenbergstraße 26
D-32758 Detmold
Germany

www.weidmueller.com

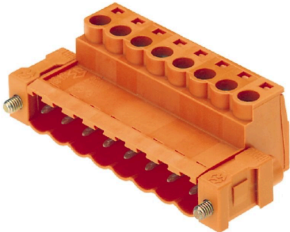
Counterpart**SLS 5.08/180FI**

Male plugs with clamping-yoke screw wire-connect system. The male plugs provide space for labelling and can be coded.

General ordering data

Type	SLS 5.08/02/180FI SN OR...	Version
Order No.	1846210000	PCB plug-in connector, male plug, 5.08 mm, Number of poles: 2,
GTIN (EAN)	4032248362493	180°, Clamping yoke connection, Clamping range, max. : 3.31 mm²,
Qty.	90 ST	Box