

## BLDF 5.08/06/180F SN BK BX

Weidmüller Interface GmbH & Co. KG

Klingenbergstraße 26

D-32758 Detmold

Germany

www.weidmueller.com

### Product image

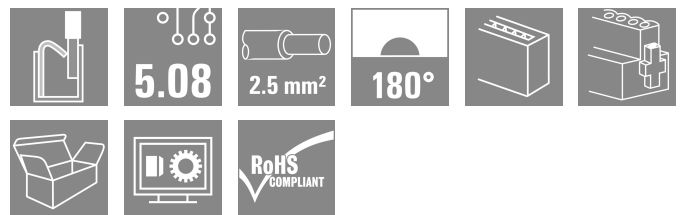
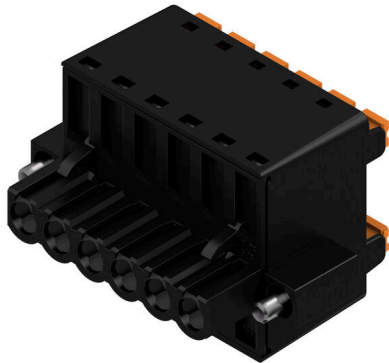

The powerful daisy-chain solution for high-performance signal bus applications is also suitable for 400V auxiliary power chains with 18.5A current-carrying capacity. The large clamping capacity (up to 2.5mm<sup>2</sup> wire cross-sections) is particularly beneficial for long bus cables or high currents because of the low voltage drop.

Four flange variations, including the patented release latch, allow for user-friendly unplugging designs.

### General ordering data

Version	PCB plug-in connector, female plug, 5.08 mm, Number of poles: 6, 180°, PUSH IN with actuator, Clamping range, max. : 3.31 mm <sup>2</sup> , Box
Order No.	<a href="#">1000980000</a>
Type	BLDF 5.08/06/180F SN BK BX
GTIN (EAN)	4032248817375
Qty.	28 items
Product data	IEC: 400 V / 20.8 A / 0.2 - 2.5 mm <sup>2</sup> UL: 300 V / 18.5 A / AWG 12 - AWG 26
Packaging	Box

## BLDF 5.08/06/180F SN BK BX

Weidmüller Interface GmbH & Co. KG  
Klingenbergstraße 26  
D-32758 Detmold  
Germany

www.weidmueller.com

## Technical data

## Approvals

Approvals



ROHS Conform

UL File Number Search [UL Website](#)

Certificate No. (cURus) E60693

## Dimensions and weights

Depth	28.3 mm	Depth (inches)	1.1142 inch
Height	24.7 mm	Height (inches)	0.9724 inch
Width	40.28 mm	Width (inches)	1.5858 inch
Net weight	18.35 g		

## Environmental Product Compliance

RoHS Compliance Status Compliant without exemption

REACH SVHC No SVHC above 0.1 wt%

## System Parameters

Product family	OMNIMATE Signal - series BL/SL 5.08		
Type of connection	Field connection		
Wire connection method	PUSH IN with actuator		
Pitch in mm (P)	5.08 mm		
Pitch in inches (P)	0.200 "		
Conductor outlet direction	180°		
Number of poles	6		
L1 in mm	25.40 mm		
L1 in inches	1.000 "		
Number of rows	1		
Pin series quantity	1		
Rated cross-section	2.5 mm <sup>2</sup>		
Touch-safe protection acc. to DIN VDE 57 106	Safe from finger touch		
Touch-safe protection acc. to DIN VDE 0470	IP20 plugged/ IP10 unplugged		
Protection degree	IP20		
Volume resistance	≤5 mΩ		
Can be coded	Yes		
Stripping length	10 mm		
Screwdriver blade	0.6 x 3.5		
Screwdriver blade standard	DIN 5264		
Plugging cycles	25		
Plugging force/pole, max.	9.5 N		
Pulling force/pole, max.	7.5 N		
Tightening torque	Torque type	Screw flange	
	Usage information	Tightening torque	min. 0.2 Nm max. 0.25 Nm

## Material data

Insulating material	PBT	Colour	black
Colour of operational elements	orange	Colour chart (similar)	RAL 9011

## BLDF 5.08/06/180F SN BK BX

**Weidmüller Interface GmbH & Co. KG**

Klingenbergstraße 26

D-32758 Detmold

Germany

www.weidmueller.com

## Technical data

Insulating material group	IIIa	Comparative Tracking Index (CTI)	≥ 200
Moisture Level (MSL)		UL 94 flammability rating	V-0
Contact material	Cu-alloy	Contact surface	tinned
Layer structure of plug contact	4...8 µm Sn hot-dip tinned	Storage temperature, min.	-40 °C
Storage temperature, max.	70 °C	Operating temperature, min.	-50 °C
Operating temperature, max.	100 °C	Temperature range, installation, min.	-30 °C
Temperature range, installation, max.	100 °C		

### Conductors suitable for connection

Clamping range, min.	0.13 mm <sup>2</sup>
Clamping range, max.	3.31 mm <sup>2</sup>
Wire connection cross section AWG, min.	AWG 26
Wire connection cross section AWG, max.	AWG 12
Solid, min. H05(07) V-U	0.2 mm <sup>2</sup>
Solid, max. H05(07) V-U	2.5 mm <sup>2</sup>
Flexible, min. H05(07) V-K	0.2 mm <sup>2</sup>
Flexible, max. H05(07) V-K	2.5 mm <sup>2</sup>
w. plastic collar ferrule, DIN 46228 pt 4, min.	0.25 mm <sup>2</sup>
w. plastic collar ferrule, DIN 46228 pt 4, max.	2.5 mm <sup>2</sup>
w. wire end ferrule, DIN 46228 pt 1, min.	0.25 mm <sup>2</sup>
w. wire end ferrule, DIN 46228 pt 1, max.	2.5 mm <sup>2</sup>
Plug gauge in accordance with EN 60999 a x b; ø	2.8 mm x 2.0 mm

Clampable conductor	Cross-section for conductor connection	Type	fine-wired
		nominal	0.5 mm <sup>2</sup>
wire end ferrule	wire end ferrule	Stripping length	nominal 12 mm
		Recommended wire-end ferrule	<a href="#">H0,5/16 OR</a>
		Stripping length	nominal 10 mm
		Recommended wire-end ferrule	<a href="#">H0,5/10</a>
Cross-section for conductor connection	wire end ferrule	Type	fine-wired
		nominal	0.75 mm <sup>2</sup>
		Stripping length	nominal 12 mm
		Recommended wire-end ferrule	<a href="#">H0,75/16 W</a>
Cross-section for conductor connection	wire end ferrule	Stripping length	nominal 10 mm
		Recommended wire-end ferrule	<a href="#">H0,75/10</a>
		Type	fine-wired
		nominal	1 mm <sup>2</sup>
Cross-section for conductor connection	wire end ferrule	Stripping length	nominal 12 mm
		Recommended wire-end ferrule	<a href="#">H1,0/16D R</a>
		Stripping length	nominal 10 mm
		Recommended wire-end ferrule	<a href="#">H1,0/10</a>
Cross-section for conductor connection	wire end ferrule	Type	fine-wired
		nominal	1.5 mm <sup>2</sup>
		Stripping length	nominal 10 mm
		Recommended wire-end ferrule	<a href="#">H1,5/10</a>
		Stripping length	nominal 12 mm

**BLDF 5.08/06/180F SN BK BX**

**Weidmüller Interface GmbH & Co. KG**  
 Klingenbergstraße 26  
 D-32758 Detmold  
 Germany

www.weidmueller.com

**Technical data**

		Recommended wire-end ferrule	<a href="#">H1.5/16 R</a>
Cross-section for conductor connection	Type	fine-wired	
	nominal	2.5 mm <sup>2</sup>	
wire end ferrule	Stripping length	nominal	10 mm
	Recommended wire-end ferrule	<a href="#">H2.5/10</a>	
	Stripping length	nominal	13 mm
	Recommended wire-end ferrule	<a href="#">H2.5/16DS BL</a>	
Reference text	The outside diameter of the plastic collar should not be larger than the pitch (P), Length of ferrules is to be chosen depending on the product and the rated voltage.		

**Rated data acc. to IEC**

tested acc. to standard	IEC 60664-1, IEC 61984	Rated current, min. number of poles (Tu=20°C)	20.8 A
Rated current, max. number of poles (Tu=20°C)	17.4 A	Rated current, min. number of poles (Tu=40°C)	17.9 A
Rated current, max. number of poles (Tu=40°C)	14.9 A	Rated current cross-connector, min. number of poles (Ta=20°C)	28.1 A
Rated current cross-connector, max. number of poles (Ta=20°C)	23.3 A	Rated current cross-connector, min. number of poles (Ta=40°C)	24.2 A
Rated current cross-connector, max. number of poles (Ta=40°C)	19.9 A	Rated voltage for surge voltage class / pollution degree II/2	400 V
Rated voltage for surge voltage class / pollution degree III/2	320 V	Rated voltage for surge voltage class / pollution degree III/3	250 V
Rated impulse voltage for surge voltage class/ pollution degree II/2	4 kV	Rated impulse voltage for surge voltage class/ pollution degree III/2	4 kV
Rated impulse voltage for surge voltage class/ contamination degree III/3	4 kV	Short-time withstand current resistance	3 x 1s with 120 A

**Rated data acc. to CSA**

Institute (CSA)	CSA	Certificate No. (CSA)	200039-1121690
Rated voltage (Use group B / CSA)	300 V	Rated voltage (Use group D / CSA)	300 V
Rated current (Use group B / CSA)	18.5 A	Rated current (Use group D / CSA)	10 A
Wire cross-section, AWG, min.	AWG 12	Wire cross-section, AWG, max.	AWG 26
Reference to approval values	Specifications are maximum values, details - see approval certificate.		

**Rated data acc. to UL 1059**

Institute (cURus)	CURUS	Certificate No. (cURus)	E60693
Rated voltage (Use group B / UL 1059)	300 V	Rated voltage (Use group D / UL 1059)	300 V
Rated current (Use group B / UL 1059)	18.5 A	Rated current (Use group D / UL 1059)	10 A
Wire cross-section, AWG, min.	AWG 12	Wire cross-section, AWG, max.	AWG 26
Reference to approval values	Specifications are maximum values, details - see approval certificate.		

**Packing**

Packaging	Box	VPE length	353.00 mm
VPE width	140.00 mm	VPE height	38.00 mm

**BLDF 5.08/06/180F SN BK BX**

**Weidmüller Interface GmbH & Co. KG**  
 Klingenbergstraße 26  
 D-32758 Detmold  
 Germany

www.weidmueller.com

**Technical data**

**Cross-connector rated data according to DIN IEC**

Rated current cross-connector, max. number of poles (Ta=40°C)	19.9 A	Rated current cross-connector, min. number of poles (Ta=20°C)	28.1 A
Rated current cross-connector, min. number of poles (Ta=40°C)	24.2 A	Rated current cross-connector, max. number of poles (Ta=20°C)	23.3 A

**Important note**

IPC conformity      Conformity: The products are developed, manufactured and delivered according international recognized standards and norms and comply with the assured properties in the data sheet resp. fulfill decorative properties in accordance with IPC-A-610 "Class 2". Further claims on the products can be evaluated on request.

- Notes
- Additional variants on request
  - Gold-plated contact surfaces on request
  - Rated current related to rated cross-section & min. No. of poles.
  - Wire end ferrule without plastic collar to DIN 46228/1
  - Wire end ferrule with plastic collar to DIN 46228/4
  - P on drawing = pitch
  - Crimping shape "A" for wire end ferrules with PZ 6/5 crimping tool recommended.
  - The test point can only be used as potential-pickup point.
  - In accordance with IEC 61984, OMNIMATE-connectors are connectors without breaking capacity (COC). During designated use, connectors are not allowed to be engaged or disengaged when live or under load
  - Long term storage of the product with average temperature of 50 °C and maximum humidity 70%, 36 months

**Classifications**

ETIM 8.0	EC002638	ETIM 9.0	EC002638
ETIM 10.0	EC002638	ECLASS 14.0	27-46-02-02
ECLASS 15.0	27-46-02-02		

**BLDF 5.08/06/180F SN BK BX**

**Weidmüller Interface GmbH & Co. KG**  
 Klingenbergstraße 26  
 D-32758 Detmold  
 Germany

www.weidmueller.com

Drawings

Product image

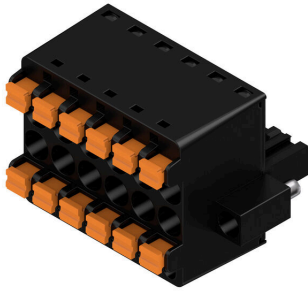

Dimensional drawing

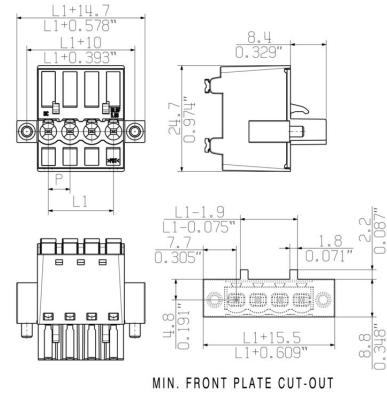

Graph

BLDF 5.08/180 - SL 5.08HC/..90

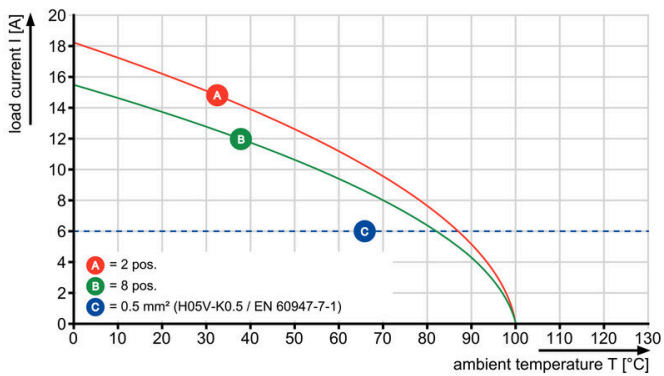

Graph

BLDF 5.08/180 - SL 5.08HC/..90

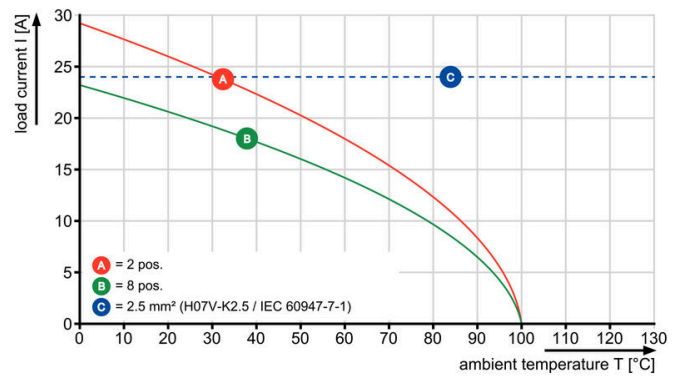

Uncompromising functionality High vibration resistance

**Drawings**

**Product benefits**

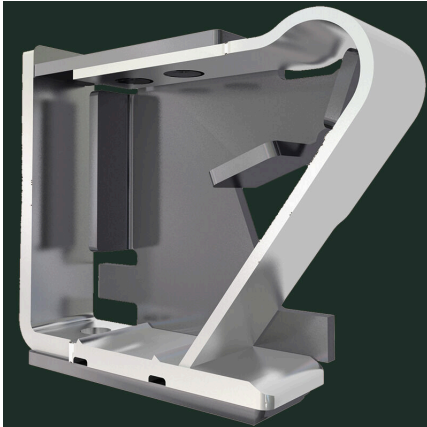

Solid PUSH IN contact Safe and durable

**Product benefits**

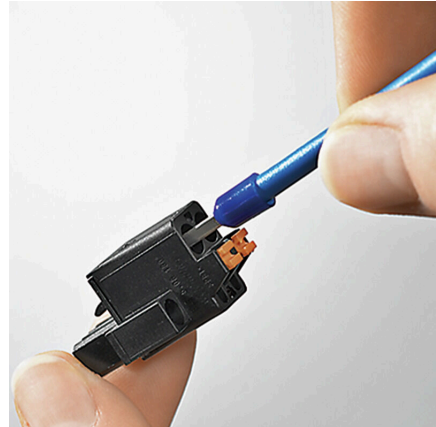

Cost-effective wiring Quick and intuitive operation

**Product benefits**

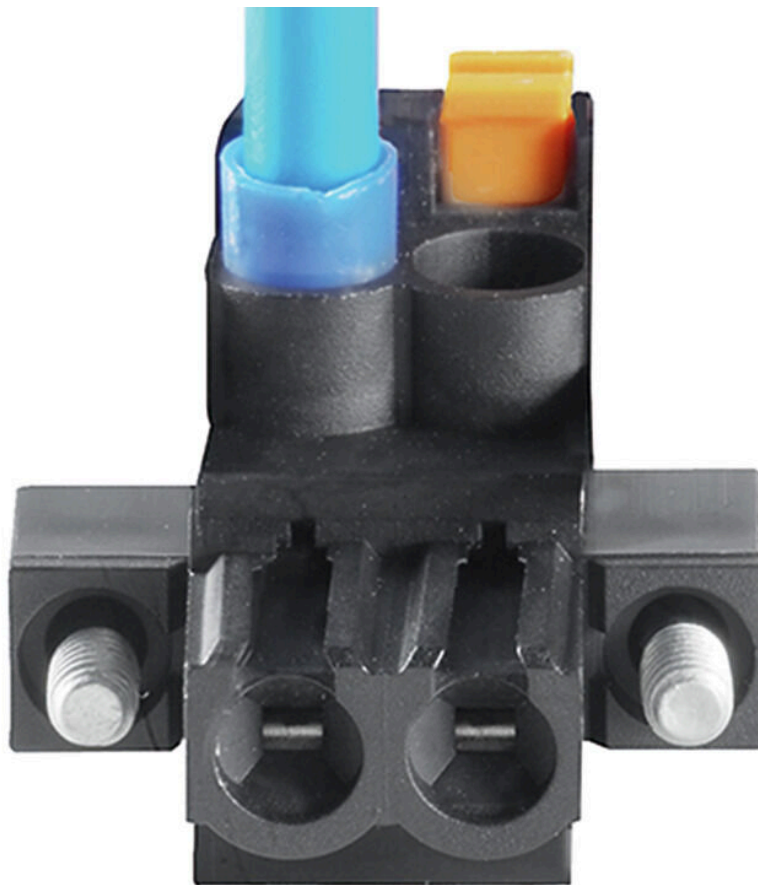

Wide clamping range Tool-free wire connection

## BLDF 5.08/06/180F SN BK BX

Weidmüller Interface GmbH & Co. KG  
Klingenbergstraße 26  
D-32758 Detmold  
Germany

www.weidmueller.com

## Accessories

## Coding elements



Only connects what is supposed to be connected: the right connection at the right place.  
Coding elements and locking devices clearly assign connecting elements during the manufacturing process and operation  
The coding elements and locking devices are inserted prior to assembly or during the cable assembly phase.  
The Weidmüller alternative: configure online using the variant configurator to precode prior to delivery.  
Incorrect assembly on the circuit board and incorrect plugging of connecting elements is no longer possible.  
The advantage: no troubleshooting during manufacture and no operational errors by the user.

## General ordering data

Type	BLZ/SL KO BK BX	Version
Order No.	<a href="#">1545710000</a>	PCB plug-in connector, Accessories, Coding element, black, Number of poles: 1
GTIN (EAN)	4008190087142	
Qty.	50 ST	
Type	BLZ/SL KO OR BX	Version
Order No.	<a href="#">1573010000</a>	PCB plug-in connector, Accessories, Coding element, orange, Number of poles: 1
GTIN (EAN)	4008190048396	
Qty.	100 ST	

## Slotted screwdriver

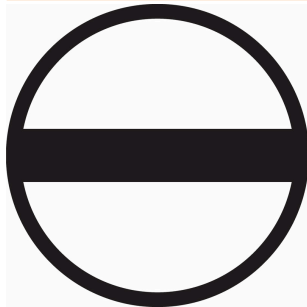

Slotted screwdriver with rounded blade SD DIN 5265, ISO 2380/2, output to DIN 5264, ISO 2380/1.  
ChromTop tip, SoftFinish grip

## General ordering data

Type	SDS 0.6X3.5X100	Version
Order No.	<a href="#">9008330000</a>	Screwdriver, Screwdriver
GTIN (EAN)	4032248056286	
Qty.	1 ST	
Type	SDS 0.6X3.5X200	Version
Order No.	<a href="#">9010110000</a>	Screwdriver, Screwdriver
GTIN (EAN)	4032248300754	
Qty.	1 ST	
Type	SDIS 0.6X3.5X100	Version
Order No.	<a href="#">9008390000</a>	Screwdriver, Screwdriver
GTIN (EAN)	4032248056354	
Qty.	1 ST	

## BLDF 5.08/06/180F SN BK BX

**Weidmüller Interface GmbH & Co. KG**  
 Klingenbergstraße 26  
 D-32758 Detmold  
 Germany

## Counterpart

www.weidmueller.com

## SL 5.08HC/180F

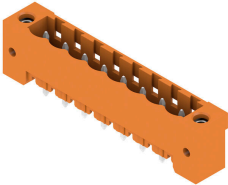

Pin headers in glass-fibre-reinforced plastic with straight wire outlet; optimised for wave soldering. The flange variant (F) can be screwed onto the respective counter piece or the circuit board. There is no need for an extra screw to connect the circuit board when the solder flange (LF) version is used. This also protects the solder points from mechanical strain. All pin headers can be manually coded or ordered pre-coded. HC = High Current.

## General ordering data

Type	SL 5.08HC/06/180F 3.2SN...	Version
Order No.	<a href="#">1148590000</a>	PCB plug-in connector, male header, Flange, THT solder connection,
GTIN (EAN)	4032248931941	5.08 mm, Number of poles: 6, 180°, Solder pin length (l): 3.2 mm,
Qty.	42 ST	tinned, black, Box
Type	SL 5.08HC/06/180F 3.2SN...	Version
Order No.	<a href="#">1147260000</a>	PCB plug-in connector, male header, Flange, THT solder connection,
GTIN (EAN)	4032248931347	5.08 mm, Number of poles: 6, 180°, Solder pin length (l): 3.2 mm,
Qty.	42 ST	tinned, orange, Box

## SL 5.08HC/180LF

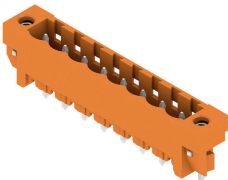

Pin headers in glass-fibre-reinforced plastic with straight wire outlet; optimised for wave soldering. The flange variant (F) can be screwed onto the respective counter piece or the circuit board. There is no need for an extra screw to connect the circuit board when the solder flange (LF) version is used. This also protects the solder points from mechanical strain. All pin headers can be manually coded or ordered pre-coded. HC = High Current.

## General ordering data

Type	SL 5.08HC/06/180LF 3.2S...	Version
Order No.	<a href="#">1149350000</a>	PCB plug-in connector, male header, Solder flange, THT solder
GTIN (EAN)	4032248932269	connection, 5.08 mm, Number of poles: 6, 180°, Solder pin length (l):
Qty.	42 ST	3.2 mm, tinned, black, Box
Type	SL 5.08HC/06/180LF 3.2S...	Version
Order No.	<a href="#">1148020000</a>	PCB plug-in connector, male header, Solder flange, THT solder
GTIN (EAN)	4032248931200	connection, 5.08 mm, Number of poles: 6, 180°, Solder pin length (l):
Qty.	42 ST	3.2 mm, tinned, orange, Box

**BLDF 5.08/06/180F SN BK BX**

**Weidmüller Interface GmbH & Co. KG**  
 Klingenbergstraße 26  
 D-32758 Detmold  
 Germany

**Counterpart**

www.weidmueller.com

**SL 5.08HC/90F**

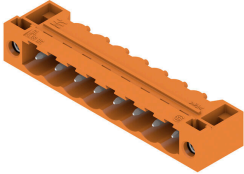

Pin headers made from glass-fibre-reinforced plastic with 90° wire outlet; optimised for wave soldering. The flange variant (F) can be screwed onto the respective counter piece or the circuit board. There is no need for an extra screw to connect the circuit board when the solder flange (LF) version is used. This also protects the solder points from mechanical strain. All pin headers can be manually coded or ordered pre-coded. HC = High Current.

**General ordering data**

Type	SL 5.08HC/06/90F 3.2SN ...	Version
Order No.	<a href="#">1150130000</a>	PCB plug-in connector, male header, Flange, THT solder connection,
GTIN (EAN)	4032248936748	5.08 mm, Number of poles: 6, 90°, Solder pin length (l): 3.2 mm,
Qty.	42 ST	tinned, black, Box

Type	SL 5.08HC/06/90F 3.2SN ...	Version
Order No.	<a href="#">1148740000</a>	PCB plug-in connector, male header, Flange, THT solder connection,
GTIN (EAN)	4032248935789	5.08 mm, Number of poles: 6, 90°, Solder pin length (l): 3.2 mm,
Qty.	42 ST	tinned, orange, Box

**SL 5.08HC/90LF**

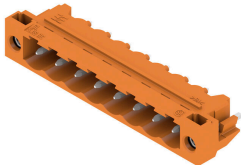

Pin headers made from glass-fibre-reinforced plastic with 90° wire outlet; optimised for wave soldering. The flange variant (F) can be screwed onto the respective counter piece or the circuit board. There is no need for an extra screw to connect the circuit board when the solder flange (LF) version is used. This also protects the solder points from mechanical strain. All pin headers can be manually coded or ordered pre-coded. HC = High Current.

**General ordering data**

Type	SL 5.08HC/06/90LF 3.2SN...	Version
Order No.	<a href="#">1150390000</a>	PCB plug-in connector, male header, Solder flange, THT solder
GTIN (EAN)	4032248937080	connection, 5.08 mm, Number of poles: 6, 90°, Solder pin length (l):
Qty.	42 ST	3.2 mm, tinned, black, Box

Type	SL 5.08HC/06/90LF 3.2SN...	Version
Order No.	<a href="#">1149510000</a>	PCB plug-in connector, male header, Solder flange, THT solder
GTIN (EAN)	4032248935895	connection, 5.08 mm, Number of poles: 6, 90°, Solder pin length (l):
Qty.	42 ST	3.2 mm, tinned, orange, Box

## BLDF 5.08/06/180F SN BK BX

**Weidmüller Interface GmbH & Co. KG**  
 Klingenbergstraße 26  
 D-32758 Detmold  
 Germany

## Counterpart

www.weidmueller.com

## SL-SMT 5.08/180F Box



High-temperature-resistant pin header, packed in box or tape. On tape, with 1.5 mm solder pin, optimised for automatic assembly. 3.2 mm solder pin suitable for reflow and wave soldering. The pin headers provide space for labelling and can be coded. HC = High Current.

## General ordering data

Type	SL-SMT 5.08HC/06/180F 1...	Version
Order No.	<a href="#">1837340000</a>	PCB plug-in connector, male header, Flange, THT/THR solder connection, 5.08 mm, Number of poles: 6, 180°, Solder pin length (l):
GTIN (EAN)	4032248345939	
Qty.	42 ST	1.5 mm, tinned, black, Box
Type	SL-SMT 5.08HC/06/180F 3...	Version
Order No.	<a href="#">1820610000</a>	PCB plug-in connector, male header, Flange, THT/THR solder connection, 5.08 mm, Number of poles: 6, 180°, Solder pin length (l):
GTIN (EAN)	4032248316571	
Qty.	42 ST	3.2 mm, tinned, black, Box

## SL-SMT 5.08/180LF Box

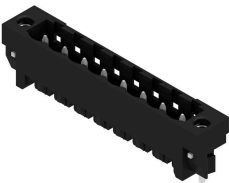

High-temperature-resistant pin header, packed in box or tape. On tape, with 1.5 mm solder pin, optimised for automatic assembly. 3.2 mm solder pin suitable for reflow and wave soldering. The pin headers provide space for labelling and can be coded. HC = High Current.

## General ordering data

Type	SL-SMT 5.08HC/06/180LF ...	Version
Order No.	<a href="#">1776402001</a>	PCB plug-in connector, male header, Solder flange, THT/THR solder connection, 5.08 mm, Number of poles: 6, 180°, Solder pin length (l):
GTIN (EAN)	4032248159185	
Qty.	42 ST	1.5 mm, tinned, black, Box
Type	SL-SMT 5.08HC/06/180LF ...	Version
Order No.	<a href="#">1838480000</a>	PCB plug-in connector, male header, Solder flange, THT/THR solder connection, 5.08 mm, Number of poles: 6, 180°, Solder pin length (l):
GTIN (EAN)	4032248348541	
Qty.	42 ST	3.2 mm, tinned, black, Box

## BLDF 5.08/06/180F SN BK BX

Weidmüller Interface GmbH & Co. KG  
Klingenbergstraße 26  
D-32758 Detmold  
Germany

## Counterpart

www.weidmueller.com

## SL-SMT 5.08/180LF Tape



High-temperature-resistant pin header, packed in box or tape. On tape, with 1.5 mm solder pin, optimised for automatic assembly. 3.2 mm solder pin suitable for reflow and wave soldering. The pin headers provide space for labelling and can be coded. HC = High Current.

## General ordering data

Type	SL-SMT 5.08HC/06/180LF ...	Version
Order No.	<a href="#">1776404001</a>	PCB plug-in connector, male header, Solder flange, THT/THR solder
GTIN (EAN)	4032248163625	connection, 5.08 mm, Number of poles: 6, 180°, Solder pin length (l):
Qty.	250 ST	1.5 mm, tinned, black, Tape

## SL-SMT 5.08/270FH Box

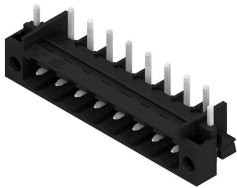

High-temperature-resistant, straight, open pin header. Packed in box or tape. On tape and with 1.5 mm solder pin, optimised for automatic assembly. 3.2 mm solder pin suitable for reflow and wave soldering. The pin headers provide space for labelling and can be coded. HC = High Current.

## General ordering data

Type	SL-SMT 5.08HC/06/270FH ...	Version
Order No.	<a href="#">1877460000</a>	PCB plug-in connector, male header, Solder flange, THT/THR solder
GTIN (EAN)	4032248468089	connection, 5.08 mm, Number of poles: 6, 270°, Solder pin length (l):
Qty.	50 ST	3.2 mm, tinned, black, Box

## SL-SMT 5.08/270FH Tape



High-temperature-resistant, straight, open pin header. Packed in box or tape. On tape and with 1.5 mm solder pin, optimised for automatic assembly. 3.2 mm solder pin suitable for reflow and wave soldering. The pin headers provide space for labelling and can be coded. HC = High Current.

## General ordering data

Type	SL-SMT 5.08HC/06/270FH ...	Version
Order No.	<a href="#">1876960000</a>	PCB plug-in connector, male header, Solder flange, THT/THR solder
GTIN (EAN)	4032248467617	connection, 5.08 mm, Number of poles: 6, 270°, Solder pin length (l):
Qty.	225 ST	1.5 mm, tinned, black, Tape

## BLDF 5.08/06/180F SN BK BX

Weidmüller Interface GmbH & Co. KG  
Klingenbergstraße 26  
D-32758 Detmold  
Germany

## Counterpart

www.weidmueller.com

## SL-SMT 5.08/270FL Box



High-temperature-resistant, straight, open pin header. Packed in box or tape. On tape and with 1.5 mm solder pin, optimised for automatic assembly. 3.2 mm solder pin suitable for reflow and wave soldering. The pin headers provide space for labelling and can be coded. HC = High Current.

## General ordering data

Type	SL-SMT 5.08HC/06/270FL ...	Version
Order No.	<a href="#">1878140000</a>	PCB plug-in connector, male header, Solder flange, THT/THR solder connection, 5.08 mm, Number of poles: 6, 270°, Solder pin length (l):
GTIN (EAN)	4032248468942	
Qty.	50 ST	1.5 mm, tinned, black, Box
Type	SL-SMT 5.08HC/06/270FL ...	Version
Order No.	<a href="#">1876890000</a>	PCB plug-in connector, male header, Solder flange, THT/THR solder connection, 5.08 mm, Number of poles: 6, 270°, Solder pin length (l):
GTIN (EAN)	4032248467471	
Qty.	50 ST	3.2 mm, tinned, black, Box

## SL-SMT 5.08/270FL Tape



High-temperature-resistant, straight, open pin header. Packed in box or tape. On tape and with 1.5 mm solder pin, optimised for automatic assembly. 3.2 mm solder pin suitable for reflow and wave soldering. The pin headers provide space for labelling and can be coded. HC = High Current.

## General ordering data

Type	SL-SMT 5.08HC/06/270FL ...	Version
Order No.	<a href="#">1877090000</a>	PCB plug-in connector, male header, Solder flange, THT/THR solder connection, 5.08 mm, Number of poles: 6, 270°, Solder pin length (l):
GTIN (EAN)	4032248467693	
Qty.	350 ST	1.5 mm, tinned, black, Tape

## SL-SMT 5.08HC/90F Box



High-temperature-resistant pin header, packed in box or tape. On tape, with 1.5 mm solder pin, optimised for automatic assembly. 3.2 mm solder pin suitable for reflow and wave soldering. The pin headers provide space for labelling and can be coded. HC = High Current.

## BLDF 5.08/06/180F SN BK BX

**Weidmüller Interface GmbH & Co. KG**  
 Klingenbergstraße 26  
 D-32758 Detmold  
 Germany

www.weidmueller.com

## Counterpart

### General ordering data

Type	SL-SMT 5.08HC/06/90F 3...	Version
Order No.	<a href="#">1837670000</a>	PCB plug-in connector, male header, Flange, THT/THR solder
GTIN (EAN)	4032248347483	connection, 5.08 mm, Number of poles: 6, 90°, Solder pin length (l):
Qty.	42 ST	3.2 mm, tinned, black, Box

### SL-SMT 5.08HC/90LF Box



High-temperature-resistant pin header, packed in box or tape. On tape, with 1.5 mm solder pin, optimised for automatic assembly. 3.2 mm solder pin suitable for reflow and wave soldering. The pin headers provide space for labelling and can be coded. HC = High Current.

### General ordering data

Type	SL-SMT 5.08HC/06/90LF 1...	Version
Order No.	<a href="#">1775272001</a>	PCB plug-in connector, male header, Solder flange, THT/THR solder
GTIN (EAN)	4032248157259	connection, 5.08 mm, Number of poles: 6, 90°, Solder pin length (l):
Qty.	50 ST	1.5 mm, tinned, black, Box
Type	SL-SMT 5.08HC/06/90LF 3...	Version
Order No.	<a href="#">1780450000</a>	PCB plug-in connector, male header, Solder flange, THT/THR solder
GTIN (EAN)	4032248165773	connection, 5.08 mm, Number of poles: 6, 90°, Solder pin length (l):
Qty.	42 ST	3.2 mm, tinned, black, Box

### SL-SMT 5.08HC/90LF Tape



High-temperature-resistant pin header, packed in box or tape. On tape, with 1.5 mm solder pin, optimised for automatic assembly. 3.2 mm solder pin suitable for reflow and wave soldering. The pin headers provide space for labelling and can be coded. HC = High Current.

### General ordering data

Type	SL-SMT 5.08HC/06/90LF 1...	Version
Order No.	<a href="#">1775274001</a>	PCB plug-in connector, male header, Solder flange, THT/THR solder
GTIN (EAN)	4032248167838	connection, 5.08 mm, Number of poles: 6, 90°, Solder pin length (l):
Qty.	350 ST	1.5 mm, tinned, black, Tape

**BLDF 5.08/06/180F SN BK BX**

**Weidmüller Interface GmbH & Co. KG**  
 Klingenbergstraße 26  
 D-32758 Detmold  
 Germany

**Counterpart**

www.weidmueller.com

**SLDV-THR 5.08/180F**

High-temperature resistant, double level, laterally offset, male connector with flange or solder flange. 1.5 mm solder pin is suitable for reflow soldering. 3.2 mm solder pin suitable for reflow and wave soldering. The pin headers provide space for labelling and can be coded.

**General ordering data**

Type	SLDV-THR 5.08/12/180F 1...	Version
Order No.	<a href="#">1828930000</a>	PCB plug-in connector, male header, Flange, THT/THR solder
GTIN (EAN)	4032248335626	connection, 5.08 mm, Number of poles: 12, 180°, Solder pin length
Qty.	28 ST	(l): 1.5 mm, tinned, black, Box
Type	SLDV-THR 5.08/12/180F 3...	Version
Order No.	<a href="#">1828810000</a>	PCB plug-in connector, male header, Flange, THT/THR solder
GTIN (EAN)	4032248335497	connection, 5.08 mm, Number of poles: 12, 180°, Solder pin length
Qty.	28 ST	(l): 3.2 mm, tinned, black, Box

**SLDV-THR 5.08/180FLF**

High-temperature resistant, double level, laterally offset, male connector with flange or solder flange. 1.5 mm solder pin is suitable for reflow soldering. 3.2 mm solder pin suitable for reflow and wave soldering. The pin headers provide space for labelling and can be coded.

**General ordering data**

Type	SLDV-THR 5.08/12/180FLF...	Version
Order No.	<a href="#">1829050000</a>	PCB plug-in connector, male header, Flange / Solder flange, THT/THR
GTIN (EAN)	4032248335749	solder connection, 5.08 mm, Number of poles: 12, 180°, Solder pin
Qty.	28 ST	length (l): 3.2 mm, tinned, black, Box

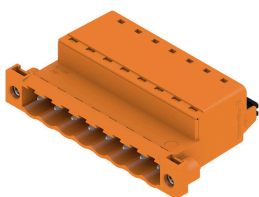
**SLF 5.08/180F SN**

Male plug with PUSH IN wire connection and straight outlet direction, when used with BLF 5.08HC as wire-to-wire application for panel feed-through. The male plugs provide space for labelling and can be coded.

## BLDF 5.08/06/180F SN BK BX

**Weidmüller Interface GmbH & Co. KG**  
Klingenbergstraße 26  
D-32758 Detmold  
Germany

www.weidmueller.com

## Counterpart

### General ordering data

Type	SLF 5.08/06/180F SN BK ...	Version
Order No.	<a href="#">1336210000</a>	PCB plug-in connector, male plug, 5.08 mm, Number of poles: 6,
GTIN (EAN)	4050118139860	180°, PUSH IN with actuator, Clamping range, max. : 3.31 mm², Box
Qty.	42 ST	
Type	SLF 5.08/06/180F SN OR ...	Version
Order No.	<a href="#">1335680000</a>	PCB plug-in connector, male plug, 5.08 mm, Number of poles: 6,
GTIN (EAN)	4050118139396	180°, PUSH IN with actuator, Clamping range, max. : 3.31 mm², Box
Qty.	42 ST	

### SLF 5.08/180FI SN

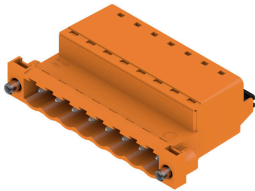

Male plug with PUSH IN wire connection and straight outlet direction, when used with BLF 5.08HC as wire-to-wire application for panel feed-through. The male plugs provide space for labelling and can be coded.

### General ordering data

Type	SLF 5.08/06/180FI SN BK...	Version
Order No.	<a href="#">1336090000</a>	PCB plug-in connector, male plug, 5.08 mm, Number of poles: 6,
GTIN (EAN)	4050118139488	180°, PUSH IN with actuator, Clamping range, max. : 3.31 mm², Box
Qty.	42 ST	
Type	SLF 5.08/06/180FI SN OR...	Version
Order No.	<a href="#">1336440000</a>	PCB plug-in connector, male plug, 5.08 mm, Number of poles: 6,
GTIN (EAN)	4050118140514	180°, PUSH IN with actuator, Clamping range, max. : 3.31 mm², Box
Qty.	42 ST	

### SLS 5.08/180F



Male plugs with clamping-yoke screw wire-connect system. The male plugs provide space for labelling and can be coded.

### General ordering data

Type	SLS 5.08/06/180F SN OR ...	Version
Order No.	<a href="#">1846400000</a>	PCB plug-in connector, male plug, 5.08 mm, Number of poles: 6,
GTIN (EAN)	4032248362103	180°, Clamping yoke connection, Clamping range, max. : 3.31 mm²,
Qty.	42 ST	Box

**BLDF 5.08/06/180F SN BK BX**

**Weidmüller Interface GmbH & Co. KG**  
Klingenbergstraße 26  
D-32758 Detmold  
Germany

**Counterpart**

[www.weidmueller.com](http://www.weidmueller.com)

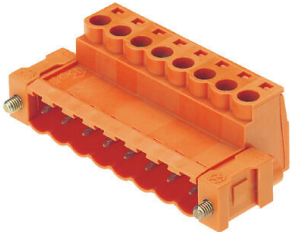
**SLS 5.08/180FI**

Male plugs with clamping-yoke screw wire-connect system. The male plugs provide space for labelling and can be coded.

**General ordering data**

Type	SLS 5.08/06/180FI SN OR...	Version
Order No.	<a href="#">1846250000</a>	PCB plug-in connector, male plug, 5.08 mm, Number of poles: 6,
GTIN (EAN)	4032248362530	180°, Clamping yoke connection, Clamping range, max. : 3.31 mm²,
Qty.	42 ST	Box