

RJ45M T1D 3.2E4N TY

Weidmüller Interface GmbH & Co. KG

Klingenbergstraße 26

D-32758 Detmold

Germany

www.weidmueller.com

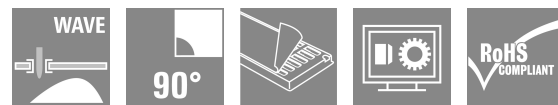
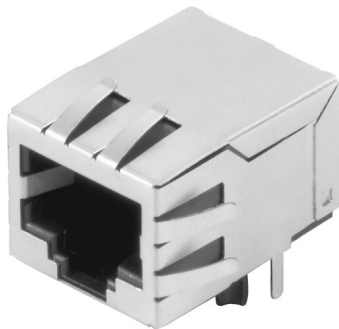

RJ45 Übertrager-Buchsen (magnetics) für Gigabit-Anwendungen (1000 Base-T) mit integrierter Kompensation wirkt aktiv induktiven und kapazitiven Kopplungen entgegen und spart Platz auf der Platine.

Das Produktsortiment umfasst folgende Ausführungen:

- 90°, liegend (horizontal) und 180°, stehend (vertikal)
- Rasthaken oben und unten (latch up / latch down)
- THT-, THR- oder SMT-Lötverfahren
- Vielzahl verschiedener Bauformen auch mit integrierte LEDs und Schirm-Kontaktflächen
- Übertragungsgeschwindigkeiten bis 1 Gbit/s
- Ausführung verpackt im Tray (TY) oder auf Rolle (Tape-on-Reel, RL)
- Kompatibel mit modularem RJ45 Stecker gemäß ANSI / TIA-1096-A und IEC 60603
- Spannungsfestigkeit $\geq 1500V$ AC RMS (2250V AC Scheitelwert) gemäß IEEE 802.3
- Spannungsfestigkeit $\geq 1500V$ AC (Scheitelwert) oder $\geq 1500V$ DC gemäß IEC 60603
- Erfüllung der Anforderungen nach IEEE 802.3 (1000Base-T, 1Gbit/s, IEEE 802.3ab bzw. 100Base-Tx, 100Mbit/s, IEEE 802.3u) Eigenschaften und Vorteile:
- Erweiterter Temperaturbereich von $-40^\circ C$ bis $+85^\circ C$, für maximale Leistungsfähigkeit
- Verstärkte Goldschicht ($30\mu''$) für verbesserten Korrosionsschutz
- Mindestens 0,3mm Stand-off gewährleistet ein perfektes Lötergebnis

Allgemeine Bestelldaten

Ausführung	OMNIMATE Data – RJ45-Übertragerbuchse, Leiterplattensteckverbinder, THT-Lötanschluss, 90°, unten, 6 tabs, Nein, Steckzyklen: 750, Polzahl: 8, PA 6T, 30...80 μ'' Ni / $\geq 30 \mu''$ Au , Tray (Handbestückung)
Best.-Nr.	2474160000
Art	RJ45M T1D 3.2E4N TY
GTIN (EAN)	4050118485943
VPE	120 ST
Verpackung	Tray (Handbestückung)

RJ45M T1D 3.2E4N TY

Weidmüller Interface GmbH & Co. KG

Klingenbergstraße 26
D-32758 Detmold
Germany

www.weidmueller.com

Technische Daten

Zulassungen

Zulassungen



ROHS	Konform
UL File Number Search	UL Webseite
Zertifikat-Nr. (cURus)	E471884

Abmessungen und Gewichte

Tiefe	21.35 mm	Tiefe (inch)	0.8405 inch
Höhe	16.8 mm	Höhe (inch)	0.6614 inch
Höhe niedrigstbauend	13.5 mm	Breite	15.9 mm
Breite (inch)	0.626 inch	Nettogewicht	3.24 g

Umweltanforderungen

RoHS-Konformitätsstatus	Konform ohne Ausnahme
REACH SVHC	Keine SVHC über 0,1 Gew.-%

Elektrische Eigenschaften

Spannungsfestigkeit Kontakt / Schirm	1500 V DC	Spannungsfestigkeit Kontakt / Kontakt	1000 V DC
Isolationswiderstand	≥ 500 MΩ	Nennspannung	125 V
Nennstrom	1,5 A		

Normen

Steckverbinder Norm	IEC 60603-7
---------------------	-------------

Systemkennwerte

Polzahl	8	LED	Nein
Lötstiftlänge (l)	3.2 mm	Montage auf der Leiterplatte	THT-Lötanschluss
Raster in Zoll (P)	0.050 "	Schirmmaterial	Messing
Schirmung	Ja	Seitenabschluss, Eigenschaft	Lötflansch
Bestückungsloch-Durchmesser Toleranz (D)	± 0,1 mm	Übertragungsrate	10/100 MBit/s
Anzahl Lötstifte pro Pol	1	Anschlussart	Lötanschluss
Bestückungsloch-Durchmesser (D)	0.9 mm	Produktfamilie	OMNIMATE Data - RJ45-Übertragerbuchse
Raster in mm (P)	1.27 mm	Schutzart	IP20
Steckzyklen	750	Beschaltung	8-adrig
Abgangswinkel	90°	Schirmoberfläche	vernickelt
Schirm tabs	6 tabs	Leistungs-Kategorie	10/100 MBit/s
Lötverfahren	Handlöten, Wellenlöten	Riegel-Option	unten
Lötstift-Abmessungen	oktogonal	Lötstiftposition-Toleranz	± 0,1 mm

Werkstoffdaten

Isolierstoff	PA 6T	Farbe	schwarz
Farbtabelle (ähnlich)	RAL 9011	Isolierstoffgruppe	II
Kriechstromfestigkeit (CTI)	≥ 500	Isolationswiderstand	≥ 500 MΩ
Moisture Level (MSL)		Brennbarkeitsklasse nach UL 94	V-0
Kontaktbasismaterial	Phosphor-Bronze	Kontaktmaterial	Cu-leg
Kontaktoberfläche	Gold über Nickel	Schichtaufbau - Steckkontakt	30...80 μ" Ni / ≥ 30 μ" Au

RJ45M T1D 3.2E4N TY

Weidmüller Interface GmbH & Co. KG
Klingenbergstraße 26
D-32758 Detmold
Germany

www.weidmueller.com

Technische Daten

Lagertemperatur, min.	-40 °C	Lagertemperatur, max.	85 °C
Betriebstemperatur, min.	-40 °C	Betriebstemperatur, max.	85 °C

Verpackungen

Verpackung	Tray (Handbestückung)	VPE Länge	319.00 mm
VPE Breite	191.00 mm	VPE Höhe	69.00 mm

Wichtiger Hinweis

Hinweise

Klassifikationen

ETIM 8.0	EC002637	ETIM 9.0	EC002637
ETIM 10.0	EC002637	ECLASS 14.0	27-46-02-01
ECLASS 15.0	27-46-02-01		

RJ45M T1D 3.2E4N TY

Weidmüller Interface GmbH & Co. KG
 Klingenbergstraße 26
 D-32758 Detmold
 Germany

www.weidmueller.com

Zeichnungen

Maßzeichnung

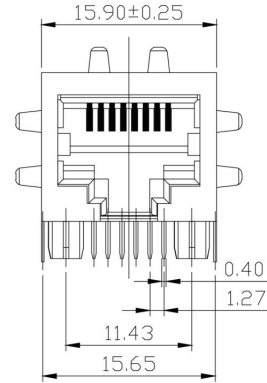
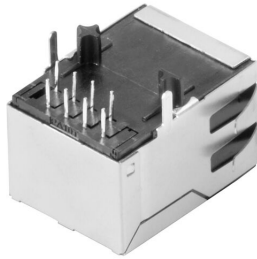

Maßzeichnung

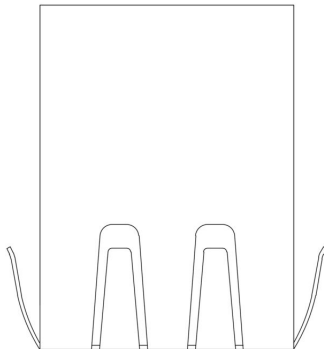

Maßzeichnung

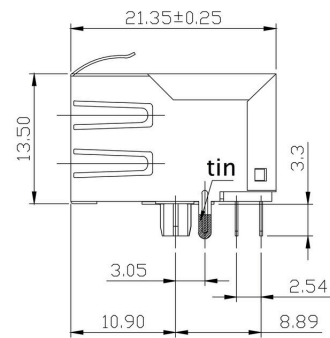

Leiterplatten-Layout

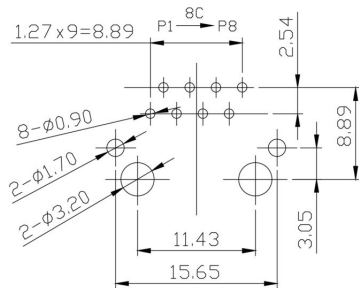

PCB LAYOUT

Schaltbild

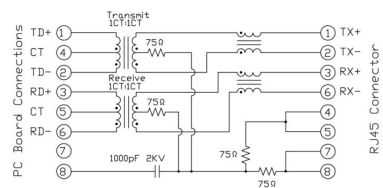

RJ45M T1D 3.2E4N TY

Weidmüller Interface GmbH & Co. KG
 Klingenbergstraße 26
 D-32758 Detmold
 Germany

Zeichnungen

www.weidmueller.com

Schaltbild

Code	Description	Options	Details																																																																																																																
RJ45	G1	R	1	U	3.2	E	4	GY/GY	TY	RJ45G1 R1U 3.2E4GY/GY TY																																																																																																									
										<table border="1"> <tr> <td>Packaging</td> <td>TY</td> <td>Tray in box (manual assembly)</td> </tr> <tr> <td></td> <td>RL</td> <td>Tape on Reel (automated assembly)</td> </tr> <tr> <td>LED</td> <td>Y/G</td> <td>Yellow/Green</td> </tr> <tr> <td></td> <td>G/Y</td> <td>Green/Yellow (standard)</td> </tr> <tr> <td></td> <td>GY/GY</td> <td>Green-Yellow/Green-Yellow</td> </tr> <tr> <td></td> <td>O/G</td> <td>Orange/Green</td> </tr> <tr> <td></td> <td>R/O</td> <td>Red/Orange</td> </tr> <tr> <td></td> <td>...</td> <td>(further combinations possible)</td> </tr> <tr> <td></td> <td>N</td> <td>without LED</td> </tr> <tr> <td>Contact surface thickness</td> <td>4</td> <td>1 = 3µ", 2 = 6µ", 3 = 15µ", 4 = 30µ", 5 = 50µ"</td> </tr> <tr> <td>EMI tabs (ground fingers)</td> <td>E</td> <td>E = with EMI tabs</td> </tr> <tr> <td></td> <td>N</td> <td>N = without EMI tabs</td> </tr> <tr> <td>Solder Pin length</td> <td>3.2</td> <td>3.2 mm</td> </tr> <tr> <td></td> <td>1.6</td> <td>1.6 mm</td> </tr> <tr> <td></td> <td>D</td> <td>SMD</td> </tr> <tr> <td>Direction, latch style</td> <td>U</td> <td>Horizontal (90°, side entry), latch up</td> </tr> <tr> <td></td> <td>D</td> <td>Horizontal (90°, side entry), latch down</td> </tr> <tr> <td></td> <td>V</td> <td>Vertical (180°, top entry)</td> </tr> <tr> <td></td> <td>Y</td> <td>Diagonal (45°), latch up</td> </tr> <tr> <td>Number of Ports</td> <td>1</td> <td>1 Port</td> </tr> <tr> <td></td> <td>12; 14; ...</td> <td>multi ports side by side, Multiport</td> </tr> <tr> <td></td> <td>21; 41; ...</td> <td>multi ports about each other, Multilevel</td> </tr> <tr> <td>Assembly on PCB</td> <td>R</td> <td>Through Hole Reflow - THR</td> </tr> <tr> <td></td> <td>S</td> <td>Surface Mount Technology - SMT</td> </tr> <tr> <td></td> <td>T</td> <td>Through Hole Technology - THT</td> </tr> <tr> <td>Performance Category</td> <td>C5</td> <td>Category 5</td> </tr> <tr> <td></td> <td>C6</td> <td>Category 6</td> </tr> <tr> <td></td> <td>C6A</td> <td>Category 6A</td> </tr> <tr> <td></td> <td>C5e</td> <td>Category 5e</td> </tr> <tr> <td></td> <td>M</td> <td>10/100 Mbit</td> </tr> <tr> <td></td> <td>G1</td> <td>10/100/1000 Mbit</td> </tr> <tr> <td></td> <td>G10</td> <td>10 Gbit</td> </tr> <tr> <td></td> <td>U</td> <td>Unshielded</td> </tr> <tr> <td></td> <td>MP</td> <td>10/100 Mbit with POE</td> </tr> <tr> <td></td> <td>MP+</td> <td>10/100 Mbit with POE+</td> </tr> </table>	Packaging	TY	Tray in box (manual assembly)		RL	Tape on Reel (automated assembly)	LED	Y/G	Yellow/Green		G/Y	Green/Yellow (standard)		GY/GY	Green-Yellow/Green-Yellow		O/G	Orange/Green		R/O	Red/Orange		...	(further combinations possible)		N	without LED	Contact surface thickness	4	1 = 3µ", 2 = 6µ", 3 = 15µ", 4 = 30µ", 5 = 50µ"	EMI tabs (ground fingers)	E	E = with EMI tabs		N	N = without EMI tabs	Solder Pin length	3.2	3.2 mm		1.6	1.6 mm		D	SMD	Direction, latch style	U	Horizontal (90°, side entry), latch up		D	Horizontal (90°, side entry), latch down		V	Vertical (180°, top entry)		Y	Diagonal (45°), latch up	Number of Ports	1	1 Port		12; 14; ...	multi ports side by side, Multiport		21; 41; ...	multi ports about each other, Multilevel	Assembly on PCB	R	Through Hole Reflow - THR		S	Surface Mount Technology - SMT		T	Through Hole Technology - THT	Performance Category	C5	Category 5		C6	Category 6		C6A	Category 6A		C5e	Category 5e		M	10/100 Mbit		G1	10/100/1000 Mbit		G10	10 Gbit		U	Unshielded		MP	10/100 Mbit with POE		MP+	10/100 Mbit with POE+
Packaging	TY	Tray in box (manual assembly)																																																																																																																	
	RL	Tape on Reel (automated assembly)																																																																																																																	
LED	Y/G	Yellow/Green																																																																																																																	
	G/Y	Green/Yellow (standard)																																																																																																																	
	GY/GY	Green-Yellow/Green-Yellow																																																																																																																	
	O/G	Orange/Green																																																																																																																	
	R/O	Red/Orange																																																																																																																	
	...	(further combinations possible)																																																																																																																	
	N	without LED																																																																																																																	
Contact surface thickness	4	1 = 3µ", 2 = 6µ", 3 = 15µ", 4 = 30µ", 5 = 50µ"																																																																																																																	
EMI tabs (ground fingers)	E	E = with EMI tabs																																																																																																																	
	N	N = without EMI tabs																																																																																																																	
Solder Pin length	3.2	3.2 mm																																																																																																																	
	1.6	1.6 mm																																																																																																																	
	D	SMD																																																																																																																	
Direction, latch style	U	Horizontal (90°, side entry), latch up																																																																																																																	
	D	Horizontal (90°, side entry), latch down																																																																																																																	
	V	Vertical (180°, top entry)																																																																																																																	
	Y	Diagonal (45°), latch up																																																																																																																	
Number of Ports	1	1 Port																																																																																																																	
	12; 14; ...	multi ports side by side, Multiport																																																																																																																	
	21; 41; ...	multi ports about each other, Multilevel																																																																																																																	
Assembly on PCB	R	Through Hole Reflow - THR																																																																																																																	
	S	Surface Mount Technology - SMT																																																																																																																	
	T	Through Hole Technology - THT																																																																																																																	
Performance Category	C5	Category 5																																																																																																																	
	C6	Category 6																																																																																																																	
	C6A	Category 6A																																																																																																																	
	C5e	Category 5e																																																																																																																	
	M	10/100 Mbit																																																																																																																	
	G1	10/100/1000 Mbit																																																																																																																	
	G10	10 Gbit																																																																																																																	
	U	Unshielded																																																																																																																	
	MP	10/100 Mbit with POE																																																																																																																	
	MP+	10/100 Mbit with POE+																																																																																																																	

Typenschlüssel

RJ45M T1D 3.2E4N TY

Weidmüller Interface GmbH & Co. KG
 Klingenbergstraße 26
 D-32758 Detmold
 Germany

www.weidmueller.com

Gegenstücke

RJ45 crimp

RJ45 Crimp-Steckverbinder gemäß IEC 60603-7-51 für Aderdurchmesser bis 1,05 mm



Allgemeine Bestelldaten

Art	IE-P	Ausführung
Best.-Nr.	8813100000	RJ45-Stecker, ohne Knickschutz; 5,5 - 7,1 mm, Cat.6A / Class EA
GTIN (EAN)	4032248512850	(ISO/IEC 11801 2010), IP20
VPE	100 ST	
Art	IE-P63	Ausführung
Best.-Nr.	8813110000	RJ45-Stecker, mit Knickschutz; 5,5 - 6,2 mm, Cat.6A / Class EA (ISO/
GTIN (EAN)	4032248512867	IEC 11801 2010), IP20
VPE	10 ST	
Art	IE-P70	Ausführung
Best.-Nr.	8813120000	RJ45-Stecker, mit Knickschutz; 6,2 - 7,1 mm, Cat.6A / Class EA (ISO/
GTIN (EAN)	4032248512874	IEC 11801 2010), IP20
VPE	10 ST	
Art	IE-PM-RJ45-TH	Ausführung
Best.-Nr.	1963580000	Stecker RJ45 Crimp, Stecker ohne Knickschutztülle, Cat.6A / Class
GTIN (EAN)	4032248645688	EA (ISO/IEC 11801 2010)
VPE	100 ST	
Art	IE-PS-RJ45-TH-BK	Ausführung
Best.-Nr.	1963590000	Stecker RJ45 Crimp, Stecker mit Knickschutztülle in schwarz,
GTIN (EAN)	4032248645695	Cat.6A / Class EA (ISO/IEC 11801 2010)
VPE	10 ST	
Art	IE-PS-RJ45-TH-BK-P	Ausführung
Best.-Nr.	2584980000	Stecker RJ45 Crimp, mit Knickschutz; 6,5 - 7,5 mm, Cat.5 (ISO/IEC
GTIN (EAN)	4050118593556	11801)
VPE	10 ST	

gerade

RJ45 Steckverbinder (werkzeuglos) gemäß IEC 60603-7-51.

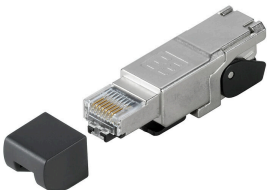

RJ45M T1D 3.2E4N TY

Weidmüller Interface GmbH & Co. KG
 Klingenbergstraße 26
 D-32758 Detmold
 Germany

Gegenstücke

www.weidmueller.com

Allgemeine Bestelldaten

Art	IE-PS-RJ45-FH-180-A-1.1	Ausführung
Best.-Nr.	1992850000	RJ45-Stecker mit Piercing-Kontakten, gerade, Cat.6A / Class EA (ISO/
GTIN (EAN)	4050118378115	IEC 11801 2010), EIA/TIA T568 A
VPE	1 ST	
Art	IE-PS-RJ45-FH-180-A-1.6	Ausführung
Best.-Nr.	1992820000	RJ45-Stecker mit Piercing-Kontakten, gerade, Cat.6A / Class EA (ISO/
GTIN (EAN)	4050118377897	IEC 11801 2010), EIA/TIA T568 A
VPE	1 ST	
Art	IE-PS-RJ45-FH-180-B-1.1	Ausführung
Best.-Nr.	1992860000	RJ45-Stecker mit Piercing-Kontakten, gerade, Cat.6A / Class EA (ISO/
GTIN (EAN)	4050118378108	IEC 11801 2010), EIA/TIA T568 B
VPE	1 ST	
Art	IE-PS-RJ45-FH-180-B-1.6	Ausführung
Best.-Nr.	1992830000	RJ45-Stecker mit Piercing-Kontakten, gerade, Cat.6A / Class EA (ISO/
GTIN (EAN)	4050118377972	IEC 11801 2010), EIA/TIA T568 B
VPE	1 ST	
Art	IE-PS-RJ45-FH-180-P-1.6	Ausführung
Best.-Nr.	1992840000	RJ45-Stecker mit Piercing-Kontakten, gerade, Cat.5 (ISO/IEC 11801),
GTIN (EAN)	4050118378023	PROFINET
VPE	1 ST	

angled with cable gland

RJ45 Steckverbinder (werkzeuglos) gemäß IEC 60603-7-51.



Allgemeine Bestelldaten

Art	IE-PS-RJ45-FH-90-A-1.1	Ausführung
Best.-Nr.	1518080000	RJ45-Stecker mit Piercing-Kontakten, gewinkelt, 4x90°, Cat.6A /
GTIN (EAN)	4050118324969	Class EA (ISO/IEC 11801 2010), EIA/TIA T568 A
VPE	1 ST	
Art	IE-PS-RJ45-FH-90-A-1.6	Ausführung
Best.-Nr.	1992870000	RJ45-Stecker mit Piercing-Kontakten, gewinkelt, 4x90°, Cat.6A /
GTIN (EAN)	4050118378054	Class EA (ISO/IEC 11801 2010), EIA/TIA T568 A
VPE	1 ST	
Art	IE-PS-RJ45-FH-90-B-1.1	Ausführung
Best.-Nr.	1518090000	RJ45-Stecker mit Piercing-Kontakten, gewinkelt, 4x90°, Cat.6A /
GTIN (EAN)	4050118325300	Class EA (ISO/IEC 11801 2010), EIA/TIA T568 B
VPE	1 ST	
Art	IE-PS-RJ45-FH-90-B-1.6	Ausführung
Best.-Nr.	1992890000	RJ45-Stecker mit Piercing-Kontakten, gewinkelt, 4x90°, Cat.6A /
GTIN (EAN)	4050118378122	Class EA (ISO/IEC 11801 2010), EIA/TIA T568 B
VPE	1 ST	

RJ45M T1D 3.2E4N TY

Weidmüller Interface GmbH & Co. KG
 Klingenbergstraße 26
 D-32758 Detmold
 Germany

www.weidmueller.com

Gegenstücke

Art	IE-PS-RJ45-FH-90-P-1.6	Ausführung
Best.-Nr.	1518100000	RJ45-Stecker mit Piercing-Kontakten, gewinkelt, 4x90°, Cat.5 (ISO/
GTIN (EAN)	4050118325232	IEC 11801), PROFINET
VPE	1 ST	

RJ45 werkzeuglos



RJ45 Steckverbinder (werkzeuglos) gemäß IEC 60603-7-51 für Aderdurchmesser bis 1,6 mm

Allgemeine Bestelldaten

Art	IE-PS-RJ45-FH-BK	Ausführung
Best.-Nr.	1963600000	RJ45 IDC-Stecker, Cat.6A / Class EA (ISO/IEC 11801 2010), 8-adrig,
GTIN (EAN)	4032248645725	4-adrig, EIA/TIA T568 A, EIA/TIA T568 B, PROFINET
VPE	10 ST	
Art	IE-PS-RJ45-FH-BK-A	Ausführung
Best.-Nr.	1132040000	RJ45 IDC-Stecker, Cat.6A / Class EA (ISO/IEC 11801 2010), 8-adrig,
GTIN (EAN)	4032248912155	EIA/TIA T568 A
VPE	10 ST	
Art	IE-PS-RJ45-FH-BK-B	Ausführung
Best.-Nr.	1132050000	RJ45 IDC-Stecker, Cat.6A / Class EA (ISO/IEC 11801 2010), 8-adrig,
GTIN (EAN)	4032248912148	EIA/TIA T568 B
VPE	10 ST	
Art	IE-PS-RJ45-FH-BK-P	Ausführung
Best.-Nr.	1132060000	RJ45 IDC-Stecker, Cat.5 (ISO/IEC 11801), 4-adrig, PROFINET
GTIN (EAN)	4032248912162	
VPE	10 ST	